



**Devoted to design.**

**SILVELOX**  
LA PORTA PER ECCELLENZA



## Index

---

- 10 The company**
- 12 Garage door**
  - Exterior design
  - Interior design
  - High-tech design
- 18 Entrance door**
  - Exterior design
  - High-tech design
- 22 Double leaf door**
- 24 Materials**
  - Wood
- 28 Models**
  - Personalisation
  - Models and characteristics
- 88 Details**
  - Woods
  - Colours
  - Windows
- 94 Structures**
  - Garage door Secur Plus
  - Garage door Secur
  - Entrance door Perfecta
  - Entrance door Optima
  - Entrance door Valida
  - Double leaf door
- 104 Accessories**
  - Mechanic
  - Pedestrian door
  - Motorisations
  - Handles
  - Total security
- 116 Warranty and certifications**
- 118 Technical sheets**
  - Specifications



## Devoted to design.

Your new home will be the fulfilment and embodiment of a dream; the ultimate lifestyle and personal statement. And, in creating it, compromise is not something you're prepared to countenance.

The journey thus far has been marked by vision and passion. Knowing precisely what you want, and fervently, unswervingly, pursuing it.

These are ideals shared by Silvelox. A devotion to design, a passion for aesthetics, an obsession with detail. Considering the significance of garage and exterior doors to the overall scheme, only a hand-crafted, individually-designed product will complement or enhance the effect you're wishing to achieve.

Quite simply, you're looking for the very best. Because second best is not in your vocabulary, or ours.







The exterior aesthetic and overall look of your home can be dramatically enhanced by the choice of doors. They often represent a significant percentage of the exterior elevation so choosing the right design solution is critical.

From Silvelox's extensive range, you will be able to select entrance, garage and double leaf doors that complement the architecture and windows of the house itself. Or, if you prefer, Silvelox will design bespoke doors to your specific requirements. Built to an exceptionally high specification, they represent an excellent investment and will greatly enhance the overall look of your property.





Fastidious attention to detail is the hallmark of the entire Silvelox range, which includes garage doors, entrance doors and double leaf doors. Specially selected woods are painstakingly hand-crafted in a multitude of styles to offer you a stunning array of finishes.

## THE COMPANY

Since 1961

---

## A heritage of craftsmanship.

Silvelox started in business over forty-five years ago creating fine furniture in Castelnuovo, Northern Italy, which is our home to this day. A love of wood, and ground-breaking new ways of using it, have remained at the heart of the business as it has grown over the decades. Today, we still believe in the art of the craftsman, and all our doors are carefully hand finished using time-honoured, traditional methods. But it is a marriage of old and new, because Silvelox operates a policy of continuous innovation and each door incorporates mechanical and electronic elements that are nothing less than state-of-the-art.

## EXTERIOR DESIGN



## Garage door

Almost an artwork in a wall.

You've spared nothing to design a home that is utterly individual and entirely unique. And your doors should reflect that same inimitable sense of style. All Silvelox doors can be personalised in a number of ways to create a point of difference (and a talking point) born of chic, understated elegance.



## INTERIOR DESIGN



## Garage door

Life on the inside.

You may have plans for your garage to be more than just a place to keep cars, perhaps it will act as an additional room to the house, maybe for hobbies or storage. As such it deserves a door that becomes it. The inside of all Silvelox doors reflect the same care and attention that have gone into the outside, and all are beautifully finished.



## HIGH-TECH DESIGN





## Garage door

Today's technology.



The handle, always a distinctive design element of Silvelox, is the technological soul of the garage door – and ease of use is at its heart. Simply rotate the handle clockwise and, via a patented system, the door will begin to raise. Turn it anti-clockwise and the pedestrian door will open.

It's the little things that make the big difference with Silvelox' ranges. Such as the way that the handle has been embedded to minute tolerances into the panel in an ergonomic approach that is both practical and aesthetic. It is supplied as standard with an exclusive Platinbronze finish, but you can chose from a multitude of alternative finishes.

In motorised models, an L.E.D. on the outside flashes to indicate the movement of the door and another on the inside acts as a courtesy light to aid vision inside the garage. On the interior side, a practical knob operates the pedestrian door and an indicator shows whether or not the door is locked.

## EXTERIOR DESIGN





## Entrance door

---

Elegance as a statement of style.

## HIGH-TECH DESIGN



## Entrance door

Defining the house and the householder.



The front door is an important design element that defines both the house and the householder. Silvelox entrance doors create an impressive statement and integrate sophisticated, burglar-resistant technology. Together with matching entrance and garage doors, they are available in a wide variety of styles and finishes to give your home a truly individual aspect.



## Double leaf door

Where planning may be a major consideration.



It may be that you're considering building in an architecturally sensitive area, or restoring a listed building. Both may have inherent planning restrictions. Silvelox, with its experience of complying with the most stringent Italian planning regulations relating to listed buildings and historic houses, will be able help you.

We can manufacture double leaf doors, to your or your architect's plans, that fully meet all planning criteria while harmonising perfectly with the building and its surroundings.







## WOOD: A TIMELESS MATERIAL

---

A craftsman's touch.



## WOOD

---

**Nature's finest.**

For durability and enduring good looks, there are few materials that can match wood. This is why it figures so heavily in Silvelox ranges. Its natural warmth, workability and capacity to accept the spectrum of quality finishes make it an ideal material for Silvelox, and for all your external doors.



## MODELS

Your options for opening.



## VARIOUS OPTIONS FOR PRESTIGIOUS SOLUTIONS

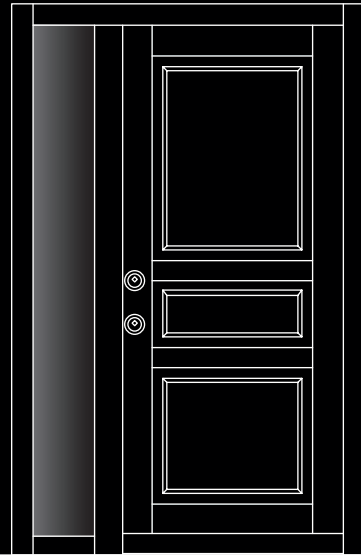
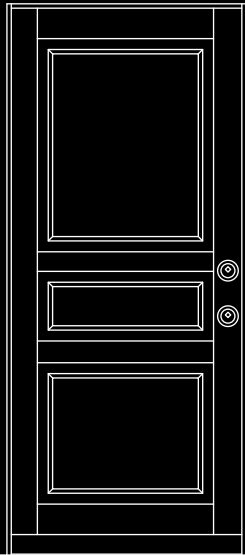

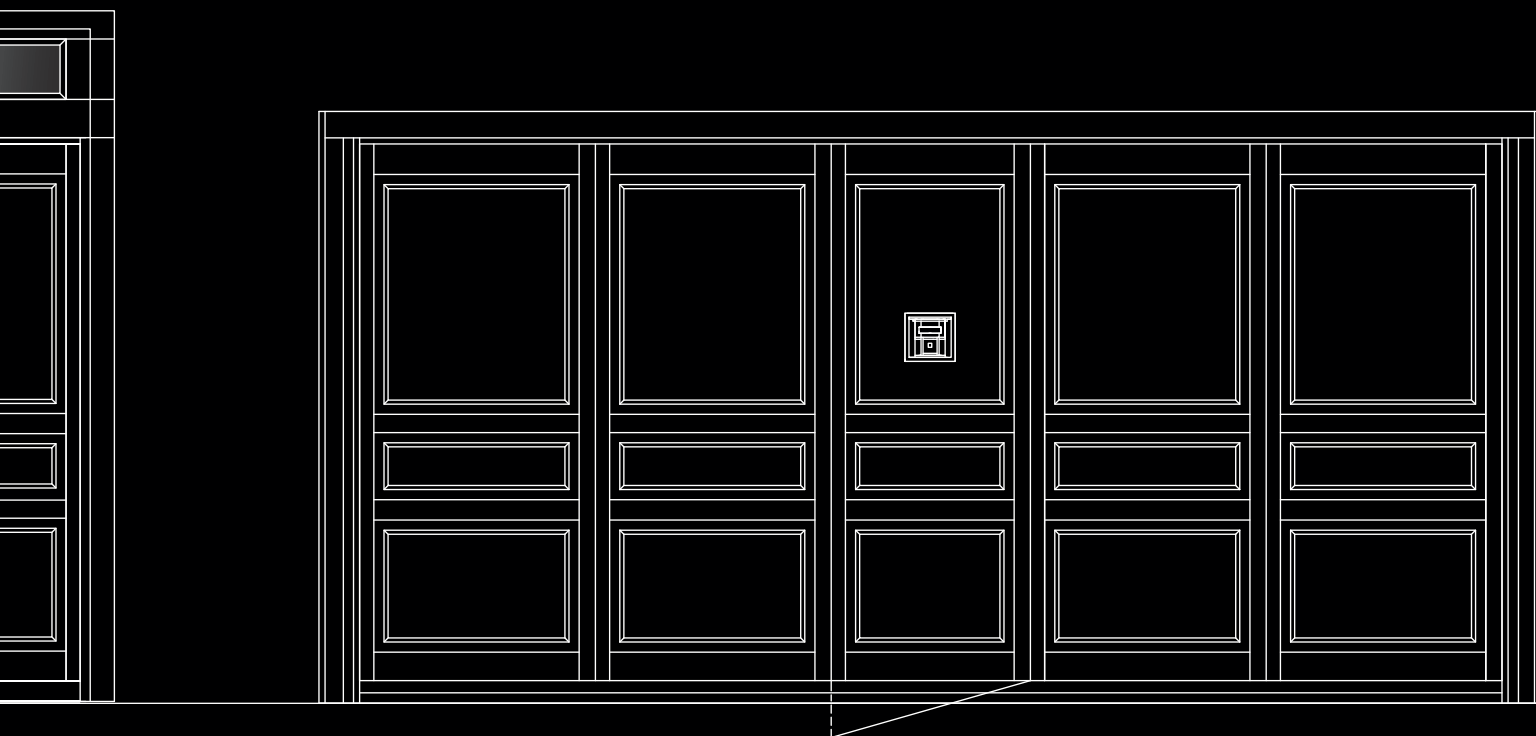

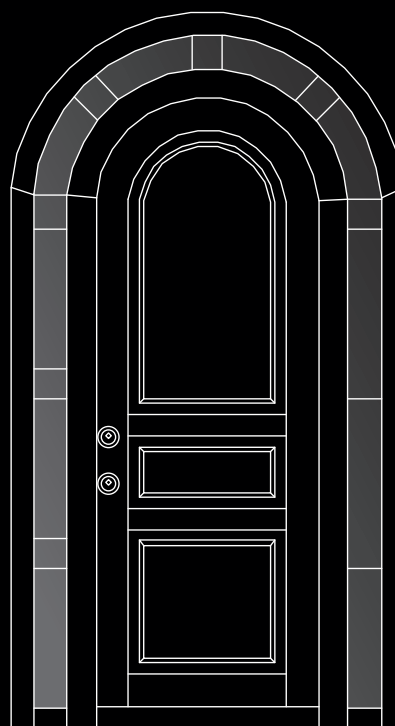
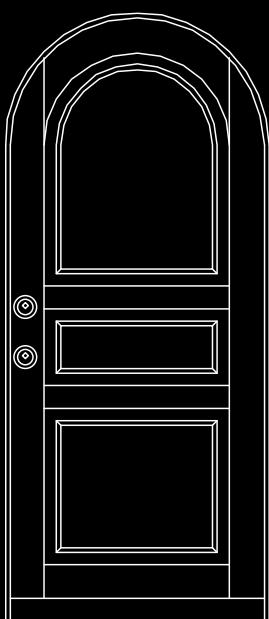
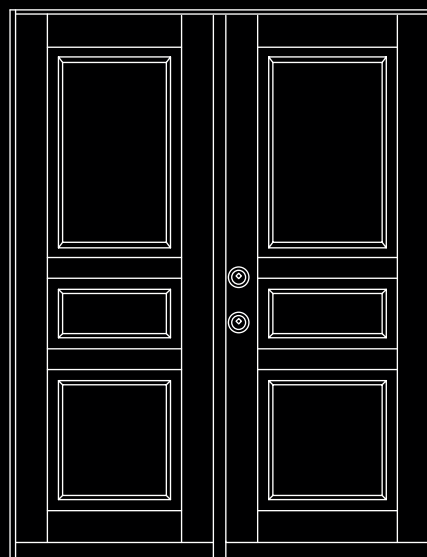
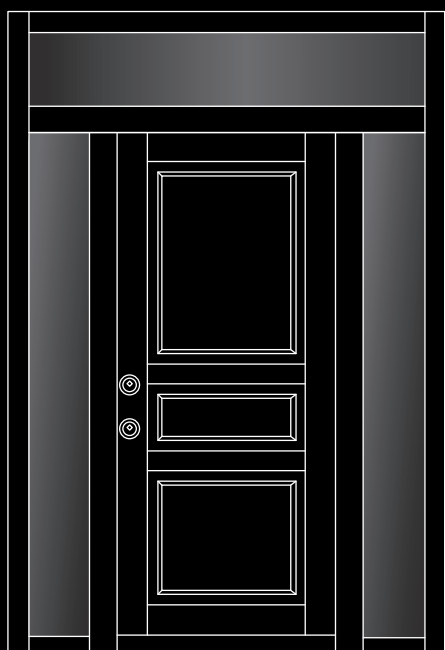



**Bespoke, custom-made doors.**

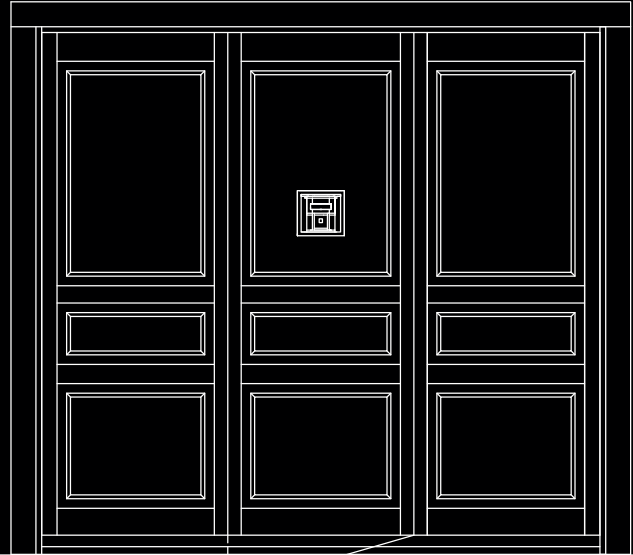

Perhaps you have very specific ideas about the doors you require. Where these cannot be met by any of the Silvelox standard ranges, we will gladly design a bespoke solution, working to your own or your architect's brief.

## ARA MODEL





## ARA MODEL



### Wood

Okoume.

### Finish

RAL 9010 Pure white.

### Accessories

Handle and matching lower leaf crossbar finished in Platinsilver.

Clean, crisp modern doors with a neo-classic geometrical design.



### **Garage door**

Available in series Secur Plus, Secur.

### **Entrance door**

Available in series Perfecta, Optima, Valida.

### **Double leaf door**

Usually custom-made to order, once feasibility has been ascertained by the Silvelox technical office.

## VIP MODEL





## VIP MODEL



### Wood

Okoume.

### Finish

Walnut.



Vertical sections showcase the wood's natural grain in a design that is traditional yet timeless.

This model is also available with 100 mm wide sections - DOC model.



### Garage door

Available in series Secur Plus, Secur.

### Entrance door

Available in series Perfecta, Optima, Valida.

### Double leaf door

Usually custom-made to order, once feasibility has been ascertained by the Silvelox technical office.

## FOR MODEL





## FOR MODEL



### Wood

Okoume.

### Finish

RAL 7044 Silk grey.

### Accessories

Inserts in stainless steel, matching handle and lower leaf crossbar finished in Platinsilver.

An elegantly minimalist look enhanced by horizontal grooves with rounded edges.

For an even more distinctive appearance, grooves can carry stainless steel inserts in the case of VIP, GEO and FOR models without the pedestrian door.



### **Garage door**

Available in series Secur Plus, Secur.

### **Entrance door**

Available in series Perfecta, Optima, Valida.

### **Double leaf door**

Usually custom-made to order, once feasibility has been ascertained by the Silvelox technical office.

## GEO MODEL





## GEO MODEL



### Wood

Oak.

### Finish

Natural.

### Accessories

Handle and matching lower leaf crossbar finished in Platinsilver.



A touch of the avant-garde, with simple cross-hatched grooving.



### Garage door

Available in series Secur Plus, Secur.

### Entrance door

Available in series Perfecta, Optima, Valida.

### Double leaf door

Usually custom-made to order, once feasibility has been ascertained by the Silvelox technical office.

## ZEN MODEL





## ZEN MODEL

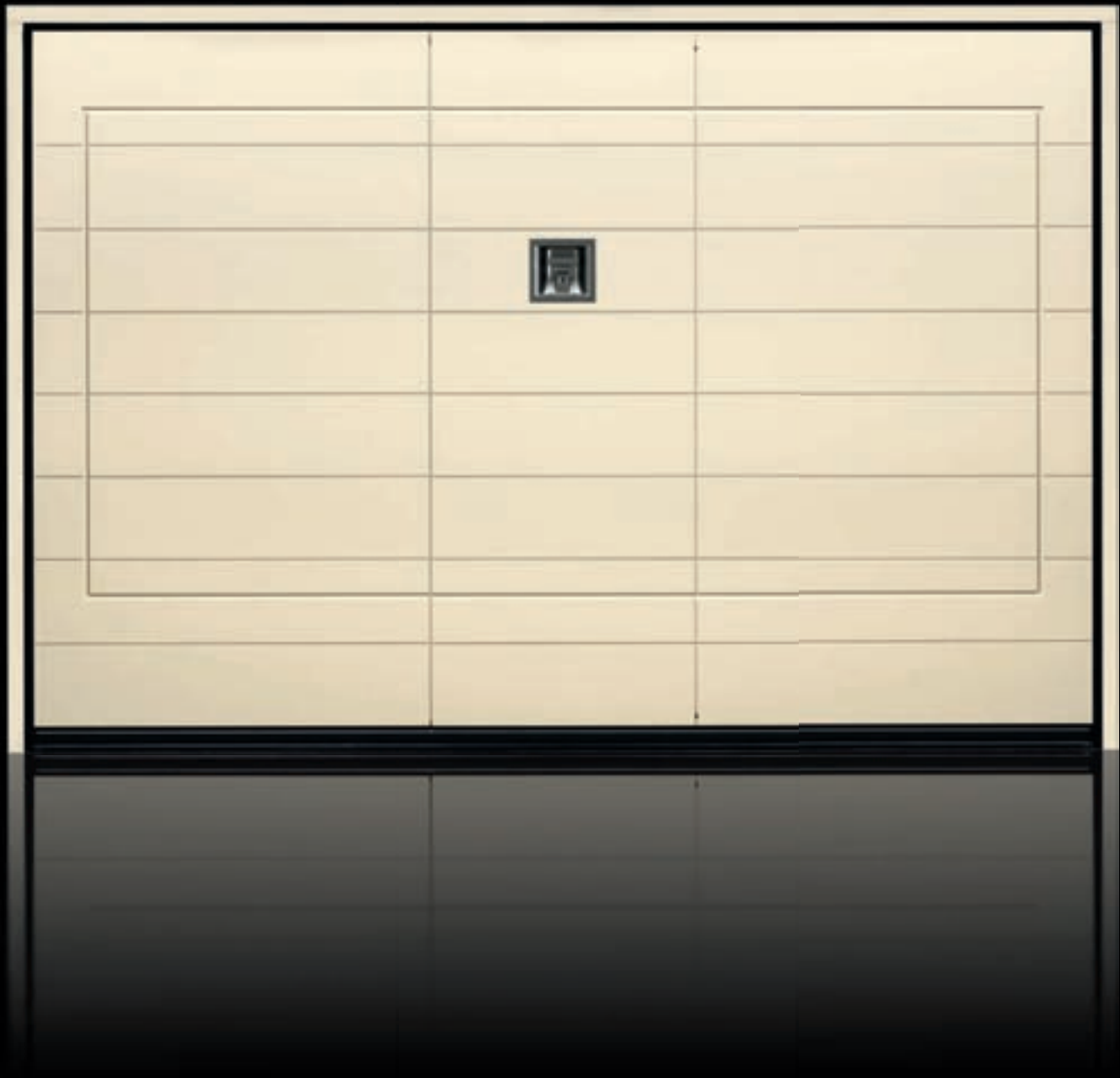

### Wood

Okoume.

### Finish

RAL 1015 Light ivory.

An understated, contemporary design using classic, geometric shapes to give elegance and clean simplicity.



### Garage door

Available in series Secur Plus, Secur.

### Entrance door

Available in series Perfecta, Optima, Valida.

### Double leaf door

Usually custom-made to order, once feasibility has been ascertained by the Silvelox technical office.

## OLD MODEL





## OLD MODEL



### Wood

Brushed Larch.

### Finish

Walnut.

### Accessories

Handle, lower leaf crossbar and matching letter box finished in Antique Bronze.



With its wide sections giving a robustly traditional look, this is a door that radiates an ageless elegance.



### Garage door

Available in series Secur Plus, Secur.

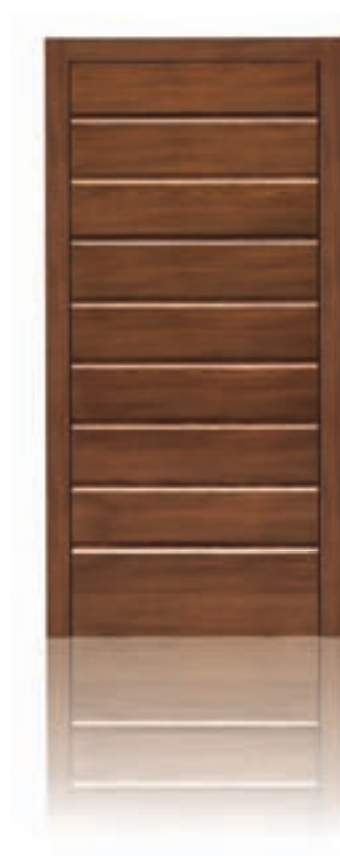

### Entrance door

Available in series Perfecta, Optima, Valida.

### Double leaf door

Usually custom-made to order, once feasibility has been ascertained by the Silvelox technical office.

# SPI MODEL





## SPI MODEL



### Wood

Northern Spruce.

### Finish

Honey.

A traditional design with a stylish herringbone groove.



### **Garage door**

Available in series Secur Plus, Secur.

### **Entrance door**

Available in series Perfecta, Optima, Valida.

### **Double leaf door**

Usually custom-made to order, once feasibility has been ascertained by the Silvelox technical office.

# TAU MODEL





## TAU MODEL



### Wood

Teak and Mahogany Meranti.

### Finish

Natural.



Soft, geometric lines are created by a deep grooving technique, which almost gives the impression that the door has been constructed of separate panels.

It is shown here with an optional contrasting mahogany inlay.



### Garage door

Available in series Secur Plus, Secur.

### Entrance door

Available in series Perfecta, Optima, Valida.

### Double leaf door

Usually custom-made to order, once feasibility has been ascertained by the Silvelox technical office.

**ARC MODEL**





## ARC MODEL



### Wood

Okoume.

### Finish

Mahogany.

### Accessories

Georgian bar windows.

Gentle curves and sweeping arches combine in a design that is as unique as it is attractive.  
Shown here accessorised with Georgian bar windows.



### **Garage door**

Available in series Secur Plus, Secur.

### **Entrance door**

Available in series Perfecta, Optima, Valida.

### **Double leaf door**

Usually custom-made to order, once feasibility has been ascertained by the Silvelox technical office.

## BIG MODEL





## BIG MODEL



### Wood

Okoume.

### Finish

RAL 6009 Pine green.



With a classic elegance evocative of the graceful Georgian era, these doors will nevertheless look stunning in both traditional and modern settings.



### Garage door

Available in series Secur Plus, Secur.

### Entrance door

Available in series Perfecta, Optima, Valida.

### Double leaf door

Usually custom-made to order, once feasibility has been ascertained by the Silvelox technical office.

## EGO MODEL





## EGO MODEL



### Wood

Okoume.

### Finish

RAL 9005 Jet black.

### Accessories

Handle and matching lower leaf crossbar finished in Antique Bronze.

A bold, striking design that will work well with more formal, period properties.



### Garage door

Available in series Secur Plus, Secur.

### Entrance door

Available in series Perfecta, Optima, Valida.

### Double leaf door

Usually custom-made to order, once feasibility has been ascertained by the Silvelox technical office.

## TOP MODEL





## TOP MODEL

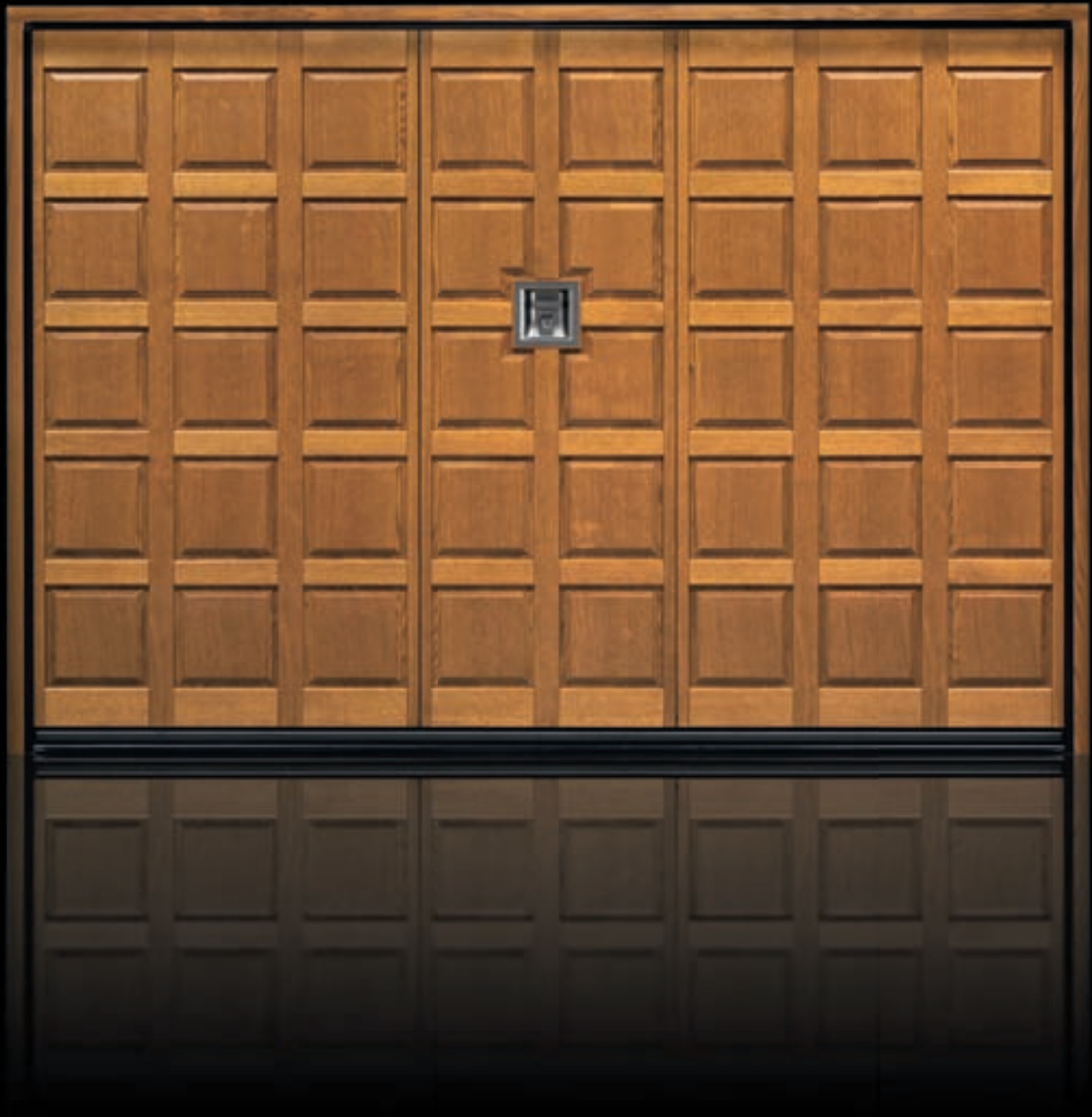

### Wood

Oak.

### Finish

Oak.



The formal matrix of tiles create a door of great prestige and character.



### Garage door

Available in series Secur Plus, Secur, according to drawing supplied by the Silvelox technical office.

### Entrance door

Available in series Perfecta, Optima, Valida, according to drawing supplied by the Silvelox technical office.

### Double leaf door

Usually custom-made to order, once feasibility has been ascertained by the Silvelox technical office.

## MET MODEL





## MET MODEL

Garage door in stainless steel with windows in satin blue security glass.



---

## A futuristic & innovative solution.

Uncompromisingly contemporary and an ideal architectonic solution for ultra-modern applications, the MET shown here has stainless steel panels available in a variety of colour ways and designs.

MET doors can be manufactured from a vast range of materials, both traditional and ultra-modern. Here we detail just a few:

- sheet of pre-varnished steel in colours pure white, grey brown, moss green and black, as shown in the Silvelox sample book.
- stainless steel sheet (satin, shiny).
- stainless steel rigid sheet, figured or electro-coloured.
- sheets of copper, brass, aluminium (upon request).

Can be designed to incorporate windows.



---

### Garage door

Available in series Secur.

---

### Entrance door

Available in series Perfecta.

## GARAGE DOOR

Silvelox doors can be supplied ready for numerous aesthetic solutions. In the example shown here, the door was provided with no exterior finish but was prepared for the application of plaster that would enable it to blend with the surrounding walls. Silvelox' designers can help you achieve any effect you or your architects may want. For instance, you may wish to supply us with special windows or colonnades, and we could integrate these into the design of the door.

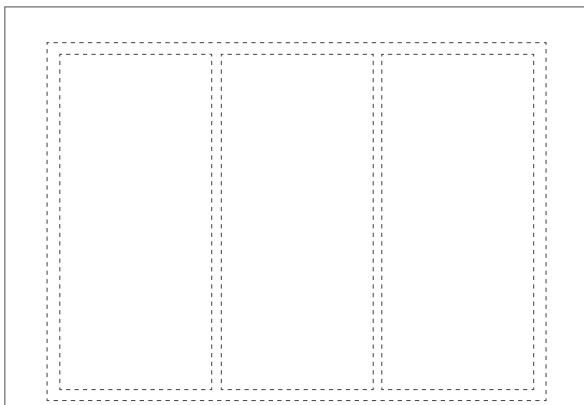

Garage door built in the wall.



The facts behind the façade.

















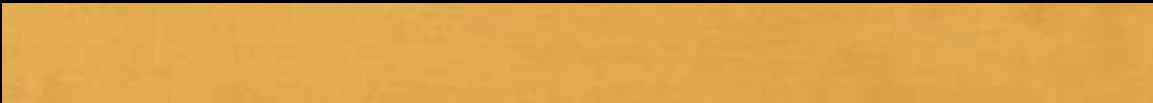
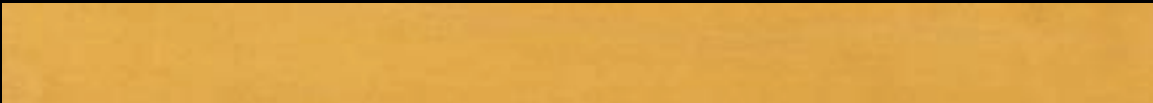

## DETAILS

---

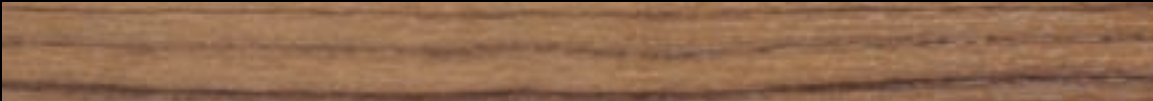
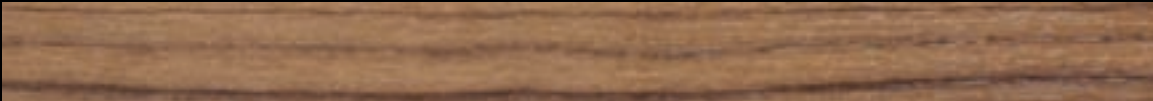
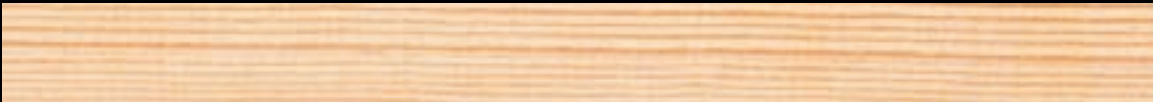
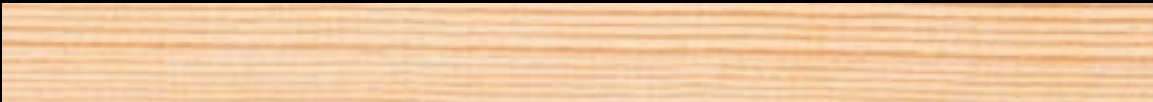
## WOODS

### Real choice, total flexibility.

Choice and flexibility are two keywords with Silvelox. Though our doors are available as standard in a selection of woods, rarer woods can be employed on request. For instance, if you felt that Okoume, Northern Spruce and Oak were not quite suitable for your project, you may prefer that we use Larch, Meranti, Chestnut, Knot-free Spruce, Teak, Douglas or Wenge instead.













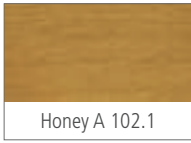
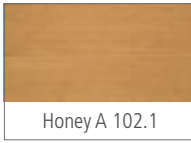



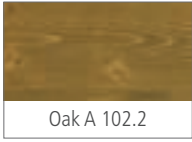

Woods	Garage door – Double leaf door	Entrance door
<b>OKOUME</b>	 Standard	 Perfecta and Optima standard - Valida standard only outside
<b>NORTHERN SPRUCE</b>	 Upon request	 Upon request - Valida not feasible
<b>OAK</b>	 Upon request	 Upon request - Valida upon request only inside
<b>DOUGLAS</b>	 Upon request	 Upon request - Valida not feasible
<b>TEAK</b>	 Upon request	 Upon request - Valida not feasible
<b>LARCH</b>	 Upon request	 Upon request - Valida not feasible
<b>KNOT - FREE SPRUCE</b>	 Upon request	 Upon request - Valida not feasible
<b>TANGANICA</b>	 Not feasible	 Valida standard only inside
<b>MAHOGANY</b>	 Not feasible	 Valida standard only inside

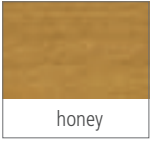
# COLOURS

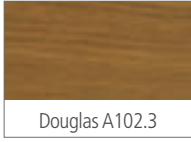
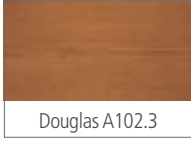
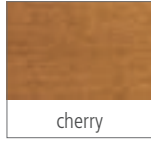
Protection guaranteed 4 years.

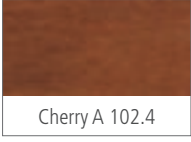
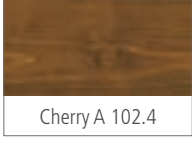
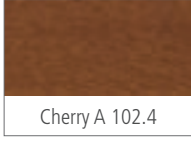
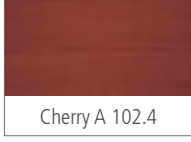

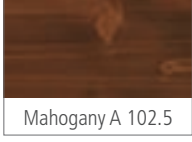
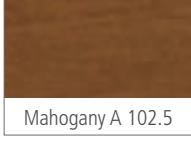

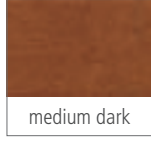
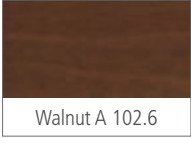
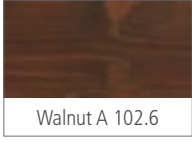
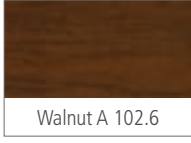
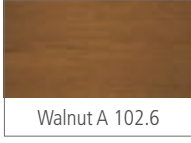
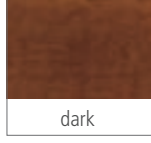
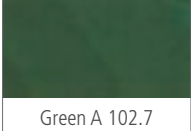
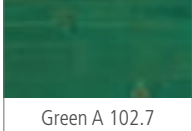
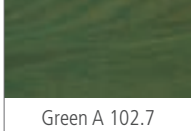
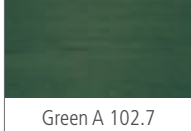
The quality transparent varnish and acrylic water-based satin finishes that we use preserve the specific characteristics of the wood and protect it against the elements for a longer life. Two alternative treatments are available: an impregnated stain with a transparent varnish finish, and an acrylic satin covering. Both finishes are guaranteed against cracking for 4 years.

## Impregnations

OKOUME	NORTHERN SPRUCE	OAK	DOUGLAS	TANGANICA	MAHOGANY	OAK
 Honey A 102.1	 Honey A 102.1	 Honey A 102.1	 Honey A 102.1	 natural	 clear	 natural
 Oak A 102.2	 Oak A 102.2	 Oak A 102.2	 Oak A 102.2	 clear	 medium	 honey
 Douglas A102.3	 Douglas A102.3	 Douglas A102.3	 Douglas A102.3	 cherry	 dark	
 Cherry A 102.4	 Cherry A 102.4	 Cherry A 102.4	 Cherry A 102.4	 medium		
 Mahogany A 102.5	 Mahogany A 102.5	 Mahogany A 102.5	 Mahogany A 102.5	 medium dark		
 Walnut A 102.6	 Walnut A 102.6	 Walnut A 102.6	 Walnut A 102.6	 dark		
 Green A 102.7	 Green A 102.7	 Green A 102.7	 Green A 102.7			

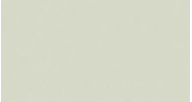
Acrylic satin covering - only for Okoume wood.

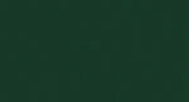
Available as standard in 6 RAL industry colours. Other shades available upon request.

					
similar RAL 9010 pure white	similar RAL 7044 silk grey	similar RAL 6033 mint turquoise	similar RAL 6009 pine gree	similar RAL 6005 moss green	similar RAL 3011 brown red

Please note, the colours shown here are approximate. For more specific details, contact Silvelox.

## WINDOWS

### Let there be light.

Silvelox offers a range of double-glazed windows that will bring light to your room and change the visual impact of the door without compromising its security characteristics.

On garage doors glazing can be of a polycarbonate material or 4/4 mm security glass. Polycarbonate is just as aesthetically pleasing as glass but is less heavy. Polycarbonate is available in embossed bronze (cincilla bronze), embossed clear and flat transparent. Security glass is available in the finishes below. The interior face of the windows is of embossed clear or flat transparent polycarbonate.

In the case of entrance doors, windows are made from laminated security glass. For the series Perfecta, this is 33 mm thick with a 6 mm airspace, and for series Optima it is 26 mm thick with a 6 mm airspace.



FLAT TRANSPARENT



SATIN WHITE



EMBOSSSED CLEAR



SATIN PINK

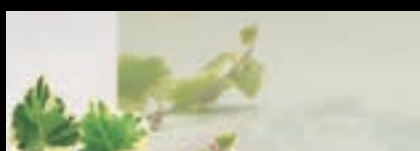

FLAT REFLECTIVE



SATIN BRONZE

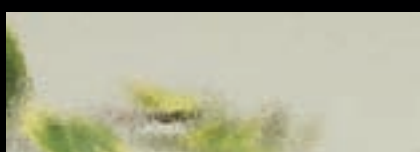

CINCILLA BRONZE (only polycarbonate or entrance doors)



SATIN BLUE (only garage doors and double leaf doors)



CINCHILLA WHITE (only entrance doors)



TRANSPARENT WHITE (only entrance doors)

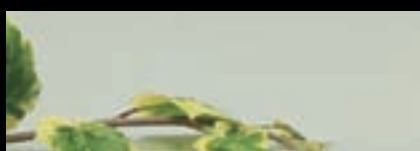

TRANSPARENT BRONZE (only entrance doors)



CATHEDRAL (only entrance doors)



## GARAGE DOOR - Series Secur Plus

Keeping you and your family secure.



- 1 Mobile bolts.
- 2 Fixing system.
- 3 Roller lug anti-unthreading plate.

When the security of your family and possessions is of the utmost importance, Silvelox offers you real peace of mind. The Silvelox Secur Plus range is certified Class 3 burglar resistant to EN 1627, the European Standard for security.

If you are looking for the highest levels of protection for your garage and home, Secur Plus will be a wise choice. While offering an exceptional degree of burglar resistance, it is virtually indistinguishable on the outside from our standard range. As a result, you will not be advertising the fact that there may be expensive cars and other valuable assets within the garage or building.

However, there is a thick steel plate laminated into the body of the door that is virtually impervious to even a sustained attack, and the frame has been strengthened to comply with EN 1627. Nevertheless, the door feels

as light and easy to use as our standard ranges, and opens fully at the turn of the handle.

- 80 mm thick leaf invisibly laminated with an integrated steel sheet backed by reinforced steel rods.
- Hardened steel hinges
- Mobile bolts have drill-resistant and anti-unthreading cylinders, invisibly protected by a manganese steel plate to protect against jemmying.
- Crossbar and uprights are reinforced with steel brackets in areas that are susceptible to break in.
- To anchor the frame to the concrete wall (or to similar structures, of mechanical resistance equal or superior to R 250 Kg/sqcm) special fixing systems are used rather than normal brackets.

**Certified Class 3 burglar resistant to European Standard EN 1627**

---



## GARAGE DOOR - Series Secur

### Beauty with hidden strength.

Like Silvelox Secur Plus, the burglar-resistant strength of our Secur range is entirely concealed within the fabric of the door. Its outward appearance and beauty make it perfect for all styles of building.

**BURGLAR RESISTANCE:** The Silvelox Secur range is certified Class 1 burglar resistant to EN 1627, the European Standard for security.

**STRUCTURAL STRENGTH:** The doors have great structural strength, are available up to 6m wide by 3.5m high and – as with all our ranges – have no unsightly ceiling tracks.

**VERSATILITY:** In addition to the models shown in this catalogue, the Secur series can be produced with many alternative exterior designs, finishes and style nuances to your brief.

**COMPONENT QUALITY:** All door components are of the highest quality and are set in, or under, 80mm panels made of select and beautifully finished woods.

**LONG LIFE:** Because wood and steel have different expansion and contraction coefficients, much effort was spent ascertaining the best way to marry the two together, for both our Secur and Secur Plus ranges. The result is a robust, weather-resistant door with an exceptional lifespan.

**HAND FINISHED:** The final stages in the production of each Secur door is conducted manually by our craftsmen, to ensure the absolute accuracy of the mechanisms and the perfection of the finish.







## ENTRANCE DOOR - Series Perfecta





A door of classic, clean simplicity, Perfecta is noted for its fine carpentry detail and remarkable technical characteristics. A nice design touch is that the door fits flush with the surrounding architrave, and has a hidden hinge enabling it to open to 135°.

An ideal door for rooms where the wall is clad, for example, in wood panelling that matches the door.

A visible hinge version is also available.

## ENTRANCE DOOR - Series Perfecta

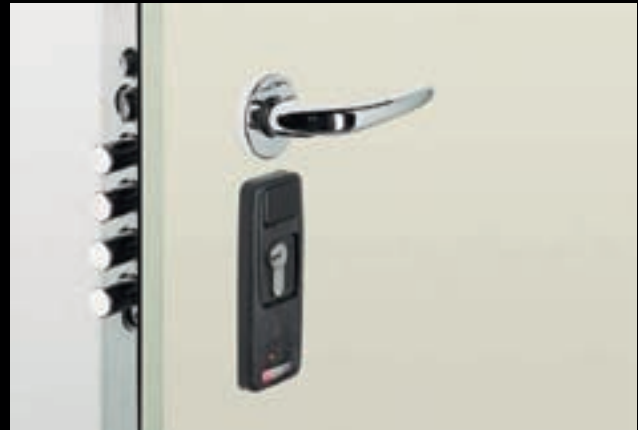

Perfecta

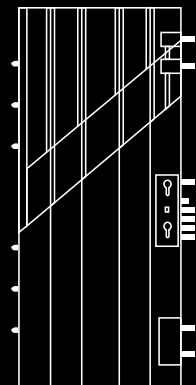

As with all Silvelox doors, Perfecta can be personalised in any number of ways to create a special aesthetic solution and an individual expression of style. The inclusion of an internal attack-proof double electro galvanised steel body assures a high standard of security as well as a long life. Perfecta has passed all tests for burglar resistance class 4, air permeability, water resistance, noise resistance and architectural performance.

The Perfecta series is available with a motorised lock operated with an electronic key (transponder) and a backup system that ensures use even in the event of a power cut.

Also, as an option, a video camera can be incorporated into the spy hole, which transmits wide-angle pictures to a separate screen.

## Series Optima and Valida



Optima also offers excellent security characteristics thanks to the inclusion of an internal double electro galvanised steel body. It has passed the following tests: burglar resistance class 3, water resistance, air permeability and noise resistance. The visible edge of the door, where the locking mechanism is sited, is finished in steel.

Optima

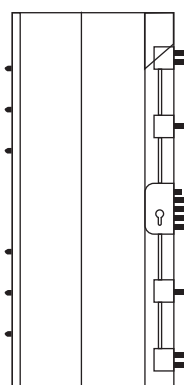

Valida

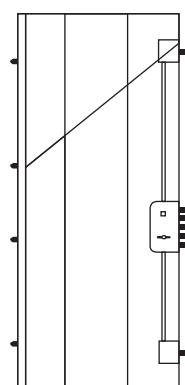

The Valida series provides high performance at an accessible price. Certified to burglar resistance class 2, it is insulated with sound absorbent material and includes a draft excluder. Though other variants are available, the handle is supplied as standard in anodised aluminium. Also, the visible edge of the door is finished with a brown, pre-varnished strip.

## DOUBLE LEAF DOOR



---

## Where tradition meets today's technology.

Silvelox double leaf doors open in a conventional 'gate' manner. However, their solid and traditional looks belie the high-technology and modern components that can be incorporated.

**SECURITY:** The double leaf door has cylinder locking devices to lock its leaves (and the pedestrian door if present). If the door is motorised, the main leaf has a multipoint lock, which is also available as an option on manual doors. This multipoint lock closes with two turns, securing the doors at different points of the leaf: one bolt at the top, one bolt at the bottom and three bolts in the central position. The leaves open and close by rotating on a ball bearing system and this can be easily adjusted to ensure a perfect, fluid movement – even after many years of use.

**PEDESTRIAN DOOR:** The incorporation of a pedestrian door offers fast and practical access, especially in the case of the larger doors. Almost indiscernible from the body of the main door, it can incorporate an hydraulic

closing device and/or an electric lock operated by intercom or by a second switch on the remote control.

**ACCESSORIES:** Numerous accessories are available to ensure the door matches sympathetically with others in the property, or in its immediate surroundings. For instance, fascias, corrosion-resistant brass studs, letter boxes and handles in a multitude of styles.

**MOTORISATION:** All Silvelox double leaf doors are pre-arranged for motorisation, and alternative automation is available to suit the different sizes of doors. The motors are almost silent, and operate the doors at a controllable speed. Internal and external photocells detect the presence of obstacles, stopping the movement where necessary. In addition, doors are supplied with a two-channel remote control, with a four-channel version available on request.

## THE MECHANISM





## Garage door

Simply better thought out.

### REDUCED PROTRUSION

All Silvelox garage doors have what we call limited protrusion. This means that there is much less forward projection when you open them. It also means that a much greater percentage of the door, when up and open, is protected inside the garage, thus shielding it from the elements.

A completely non-protruding mechanism is also available. With this, the door in its entirety slides effortlessly into the garage interior. Situations where no protrusion is important include locations where the garage faces directly onto a pavement, or in an arched opening where the geometry of the aperture would preclude any protrusion.

Neither our protruding nor our non-protruding mechanisms require the use of unsightly ceiling tracks.

### SELF-LIFTING

Silvelox' manually-operated doors open and close without any physical effort whatsoever on your part. This is achieved through a clever and patented counterbalance system that does the work for you. Just turn the handle and the door opens by itself.

### LEAF THICKNESS

The leaf is 80 mm thick and is constructed from a number of panels. The

assembly system is patented and ensures firm fastening of the panels to a metal frame, without any bolts or fixings being visible.

### MULTILAYER

The use of multilayer, marine-quality Okoume ensures great stability and high resistance even under the most challenging atmospheric conditions.

The reliability of this technique is demonstrated by the fact that this same material is used extensively for nautical applications.

### STANDARD INSULATION

Within the multilayer construction mentioned above is a honeycomb structure that provides great thermal and acoustic insulation.

### METAL COMPONENTS

For security, robustness and long working life, all steel profiles and metal components are galvanised and coated with a thick layer of heat-applied varnish before being concealed under the external wood facings.

### MOTORISATION-READY

Each door, despite having been ordered in the manual version, can be upgraded later through the addition of a Silvelox motorisation. At this stage you also have the option to link the doors to your security alarm system.

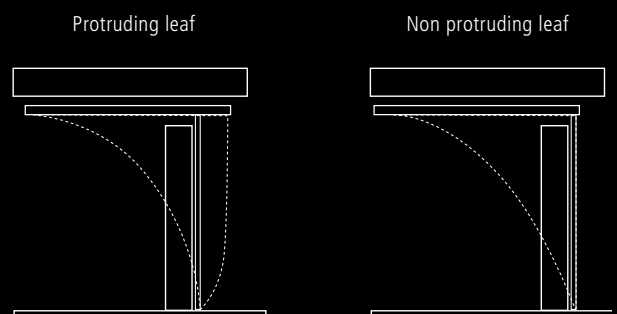

## PEDESTRIAN DOOR



## Garage door

A door within a door.



1

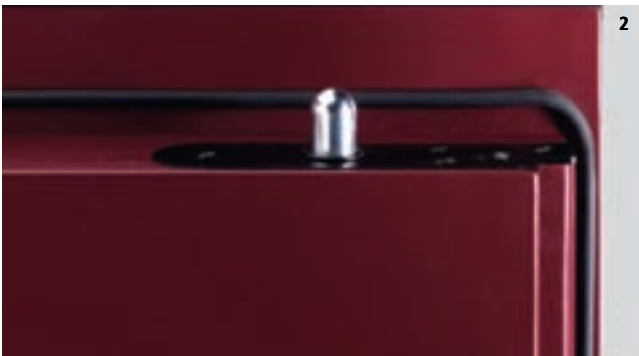

2



3

- 1 Hidden hinge.
- 2 Perimeter seal.
- 3 Detail of vertical bolt.

A pedestrian door offers easy and quick access to the garage without having to operate the whole garage door. At the same time, it offers equal burglar resistance to the main door in which it is placed.

Hardly identifiable as a separate door, it is opened with an anticlockwise turn of the main garage door handle. For convenience, the internal handle has red and green indicators, so you can see at a glance whether or not the door is locked.

The use of 2 horizontal and 2 vertical bolts, that slide into position when the door closes, guarantees maximum security against intruders, while a perimeter seal protects against the ingress of rain.

A hidden hinge system enhances the clean lines of the door further and allows it to be opened to a full 90° for ease of access. Furthermore,

the height of the threshold has been reduced to the minimum that is technically possible.

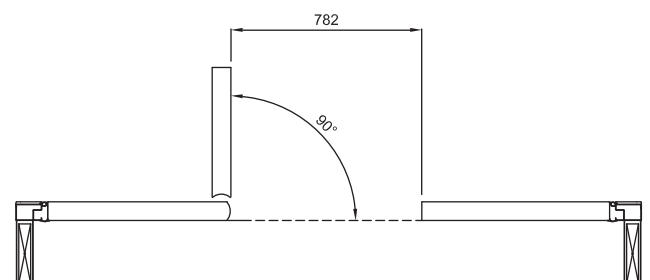

## MOTORISATIONS



In its constant pursuit of quality, Silvelox believes in overseeing the manufacture of every component part that goes into our doors. And so it was logical that, rather than pass responsibility for making the electric motors to a third party, we should do it ourselves. Produced entirely by Silvelox, and protected by an international patent, the motors are a marriage of functionality and aesthetics. But in this instance it's a case of hidden beauty, as the motor drive is concealed in the upper cross-section of the door's perimeter frame. It operates faultlessly and almost silently, requiring no unsightly ceiling tracks or impeding passage in any way. It even thinks for itself. Using auto-diagnostic electronics to detect a malfunction, the system indicates which components require attention by showing a different number of flashes on an L.E.D. display.

### COMBIMATIC

Original electromechanical motorisation, patented by Silvelox, regulates the velocity of the opening and closing phases to give a steady, controlled speed.



1



2

1 Auto diagnosis system.

2 Two or four channel remote controls.

### BLOCKMATIC

For extra protection, Blockmatic automatically slides two extra security bolts into position at the touch of a switch, and removes them when you wish to operate the door again.

### SECRMATIC

The motor has been specially developed for the Secur Plus range of garage doors. Not only does it regulate the speed of the opening/closing phases, it also controls mobile bolts that lock the door to the frame at six key security points.

### REMOTE CONTROLS WITH ROLLING CODE

Two or four channel remote controls are available, both with rolling code ID protection. Rolling code is the very latest generation of cloning and hacker-proof technology that can be incorporated into a remote control. All Silvelox remote controls are compatible with Homelink systems.

## Garage door

### Clever functionality.



1 Detail of internal view.

2 Letter box.

Silvelox doors combine beauty with practicality, so much so that the interior of the door looks as attractive and welcoming as any other door in your home.

#### VENTILATION GRILLS

Upon request, it is possible to insert grills that blend with the door design.

#### KEYS WITH PERSONALISED CODE

Each garage door is supplied with three coded keys for the operation of the opening locking cylinder, which has anti-unthreading protection.

#### ROTATION OF COUNTERWEIGHT SECTION

When manoeuvring a car in or out of a garage, particularly at an angle, every centimetre counts. To allow a slightly more sideways approach we can, on request, turn the counterweight fabrication through 90° and locate it adjacent to the frame on one or both sides of the garage door.

#### LETTER BOX

If the garage door is used also as entrance door we can design in a letter box with an external flap in the same finish as the door handle.

#### TRANSOM

In case of tall garages, where there may be a space between the top of the garage door and roof, Silvelox can supply overhead transoms that match to the design, the wood and the colour of the garage door.

#### GLAZED TRANSOM

To give more light to the garage, Silvelox can fit the transom with fixed or tilting windows.

## PLATINBRONZE

### Garage door Secur Plus and Secur.

1. External handle (standard)
2. External flap for letter box



1



2

### Entrance door Perfecta and Optima.

3. Fixed knob (standard)
4. Egg shaped handle (standard)
5. Elongated handle (standard)
6. Protection rose and external ring (standard)
7. Spy hole (outside)
8. Knocker
9. Large handle
10. External flap for letter box



9

4

7

3

8

6

5

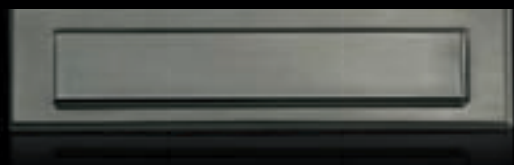

10

On request also RAL colours

## PLATINSILVER

### Garage door Secur Plus and Secur.

1. External handle
2. External flap for letter box



1



2

### Entrance door Perfecta and Optima.

3. Fixed knob (standard)
4. Egg shaped handle (standard)
5. Elongated handle (standard)
6. Protection rose and external ring (standard)
7. Spy hole (outside)
8. Knocker
9. Large handle
10. External flap for letter box
11. Internal thumb turn (standard)
12. Plate for cylinder (standard)
13. Knob for controlled opening security device
14. Spy hole (inside)



10

On request also RAL colours

## BRASS

### Garage door Secur Plus and Secur.

1. External handle
2. External flap for letter box

1



2

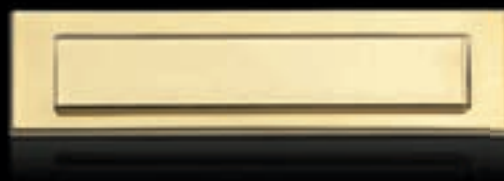

### Entrance door Perfecta and Optima.

3. Fixed knob (standard)
4. Egg shaped handle (standard)
5. Elongated handle (standard)
6. Protection rose and external ring (standard)
7. Spy hole (outside)
8. Knocker
9. Large handle
10. External flap for letter box
11. Internal thumb turn (standard)
12. Plate for cylinder (standard)
13. Knob for controlled opening security device
14. Spy hole (inside)

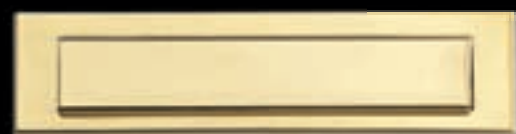

10

On request also RAL colours



## ANTIQUE BRONZE

### Garage door Secur Plus and Secur.

1. External handle
2. External flap for letter box



### Entrance door Perfecta and Optima.

3. Fixed knob
4. Egg shaped handle
5. Elongated handle
6. Protection rose and external ring
7. Spy hole (outside)
8. Knocker
9. Large handle
10. External flap for letter box



On request also RAL colours

## TOTAL SECURITY

---

Indicating compliance with community directives on security, each door is CE marked and is manufactured to Quality System UNI EN ISO 9001, for which Silvelox is certified (DNV).

### PHOTOCELLS

In the motorised version of our garage doors, the various functions are operated by a special electronic microprocessor linked to photocells which deactivate the system if an obstacle is detected. To ensure safety if this happens, the microprocessor reverses the downward movement of the door.

### SEALS

A tubular perimeter seal between the frame and door acts as a 'protective space' should fingers stray there accidentally. The base of the door has an EPDM protective seal, with double tubular external and internal protrusions, to give similar protection at ground level.

## Fixed idea.



1



2



3



4



5

1. Moving parts protected.
2. A rubber seal on the base of the door leaf protects against impacts.
3. Security mobile bolts on series Secur Plus.
4. Silblock device protects against the door dropping in the event of a mechanical failure.
5. Double perimeter seal.

## WARRANTY AND CERTIFICATIONS



**All products CE marked.**

Each Silvelox door is tested and identified by a serial number, for which a certificate is given. This certificate is provided in the Use and Maintenance manual, where the following warranties are included:

**WARRANTY ON THE MECHANISMS:**

10 YEARS on mechanical components of the door.

**WARRANTY ON VARNISH:**

4 YEARS on the duration of waterproof film applied to wood components.

**WARRANTY ON MOTORISATION:**

Garage door:

5 YEARS or 20.000 cycles (one cycle=open + close) on mechanical and electrical components of the motorisation.

2 YEARS on electronic components of the motorisation.

Double leaf door:

2 YEARS on mechanical, electrical and electronic components of the motorisation.

**WARRANTY ON ENTRANCE DOOR:**

10 YEARS on leaf and counter frame series Perfecta.

5 YEARS on leaf and counter frame series Optima.

2 YEARS on leaf and counter frame series Valida.

4 YEARS on the duration of waterproof film applied to wood components.

2 YEARS on lock components.

For its garage and double leaf doors Silvelox provides a declaration of conformity in accordance with European directive CPD (Construction Product Directive) on security matters. This makes it obligatory for the manufacturer

to test its products (some compulsory, some optional) at laboratories notified for this activity at European level.

The industry norm is to test security efficiency before any durability tests have been undertaken. Even when manufacturers do carry out durability tests, these do not usually exceed 5.000 cycles. Silvelox is unique in the world in that it tests the security of its doors after 20.000 cycles of movement.

The tests carried out, enable Silvelox to CE mark their doors as requested by the directive 89/106/CEE (CPD). The norm of product used (UNI EN13241-1) contains the list of main requirements. Amongst these the most important and compulsory are:

**MECHANICAL RESISTANCE**

**GEOMETRY OF GLASS PARTS**

**EMC (electromagnetic compatibility)**

**RELEASE OF DANGEROUS SUBSTANCES**

**SAFE OPENING**

**FUNCTIONING FORCES**

**SAFETY DEVICES**

**RESISTANCE TO WIND LOAD**

**PRODUCTION CHECK IN FACTORY**

In addition to the above, Silvelox has certified its garage doors for:

**THERMAL TRANSMITTANCE**

**BURGLAR RESISTANCE**

Irrespective of their size, all Silvelox doors fully comply with European requirements and regulations.

## GARAGE DOOR EQUIPMENT

	SECUR PLUS	SECUR
Thermal insulation	●	●
Pedestrian door	○	○
Windows	n.a.	○
Ventilation grills	n.a.	○
Transom	n.a.	○
Glazed transom	n.a.	○
Protruding mechanism	●	●
Non protruding mechanism	○	○
Security bolts	n.a.	○
Moving bolts with security key	●	n.a.
Keys with personalised code	●	●
Arrangement for a connection to alarm system	○	○
Counterweight turned through 90° and adjacent to the frame	○	○
Letter box	n.a.	○
Combimatic motorisation	n.a.	○
Securmatic motorisation	○	n.a.
Blockmatic device	n.a.	○
Remote controls with rolling code (motorised door)	○	○
Silblock - Device against door dropping	●	●
Seal for finger protection between frame and leaf	●	●
Seal for protection against impacts on the base of the leaf	●	●
Burglar resistance certification	class 3	class 1
Warranty on mechanical components of the door	10 years	10 years
Warranty on the duration of waterproof film applied to wood components	4 years	4 years
Warranty on mechanical and electrical components of the motorisation	5 years or 20.000 cycles	5 years or 20.000 cycles
Warranty on electronic components of the motorisation	2 years	2 years

● standard

○ on request

n.a. not available

## ENTRANCE DOOR EQUIPMENT

STRUCTURE	PERFECTA	OPTIMA	VALIDA
Leaf with frame and counter frame	•	•	•
Internal construction with double electro galvanised steel	•	n.a.	n.a.
Internal construction with omega shaped electro galvanised steel	n.a.	2 omega	1 omega
Cisa Revolution lock with two lock cylinders with homeowner function and internal thumb turn	•	n.a.	n.a.
Cisa Revolution lock with one cylinder with internal thumb turn	n.a.	•	◦
Cisa Sage Easy Change cylinder	n.a.	n.a.	•
Key qty (homeowner/cylinder/site)	5+3+1	n.a.	n.a.
Key qty (cylinder/site)	n.a.	3+1	n.a.
Key qty (sage/site)	n.a.	n.a.	3+1
Controlled opening security device	◦	◦	◦
Manganese total lock protection system	•	n.a.	n.a.
Hinge bolts	6	6	4
Spy hole	◦	◦	◦
Hidden hinge (leaf opening to 135°)	•	n.a.	n.a.
<b>PANELS</b>			
External panel – 15 mm Okoume multilayer, Northern Spruce, or Okoume multilayer with Oak or Douglas front face	•	•	n.a.
External panel – 15 mm Okoume multilayer	n.a.	n.a.	•
Internal smooth panel – 10 mm Okoume multilayer	•	•	n.a.
Internal smooth panel – 6 mm engineered Tanganica or Mahogany	n.a.	n.a.	•
<b>INSULATION THERMAL/ACOUSTIC:</b>			
Aluminium single contact threshold and thermal/acoustic insulation	•	◦	n.a.
Stainless steel double contact threshold and thermal/acoustic insulation	◦	n.a.	n.a.
Draft excluder built into door leaf base	◦	•	•
Insulation with sound absorbent material	•	•	•
<b>FINISHES</b>			
Handle Platinbronze, Platinsilver or in brass PVD treated	•	•	◦
Handle Antique Bronze	◦	◦	n.a.
Handle in aluminium anodised bronze colour	n.a.	n.a.	•
External frame cover boards	◦	◦	◦
External transom and lateral cover boards	•	•	n.a.
Internal frame cover boards	•	◦	n.a.
Internal window transom and lateral cover boards	•	◦	n.a.
<b>WARRANTIES</b>			
Warranty on leaf and counter frame	10 years	5 years	2 years
Warranty on locks	2 years	2 years	2 years
Warranty on the duration of waterproof film applied to wood components	4 years	4 years	4 years
<b>CERTIFICATIONS FOR 1 LEAF DOORS</b>			
Burglar resistance	class 4	class 3	class 2
Water resistance	class 2		
Wind resistance	class 5	class 3	class 3
Air permeability	class 2	class 2	class 2
Noise resistance	dB 40	dB 40	dB 32

• standard

◦ on request

n.a. not available

# INSTALLATION TYPES AND OVERALL SIZES - Garage door

## Installation between brickwork

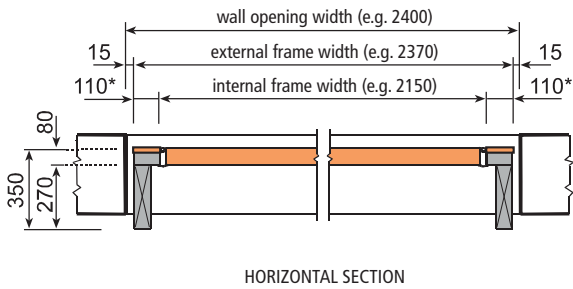

\*: becomes 135 mm in the cases shown in the size tables

PASSAGE WIDTH = internal frame width -50 mm

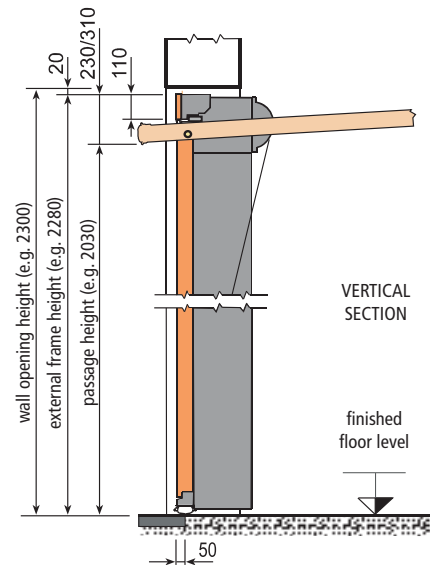

## Installation behind brickwork

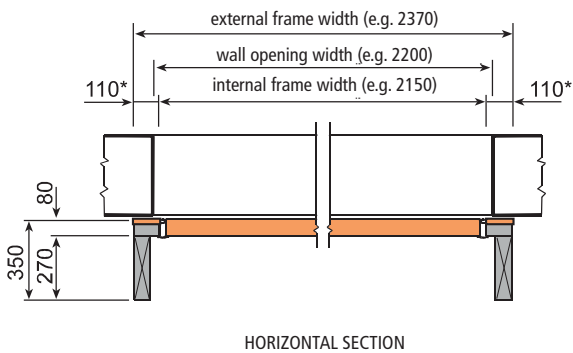

\*: becomes 135 mm in the cases shown in the size tables

PASSAGE WIDTH = internal frame width -50 mm

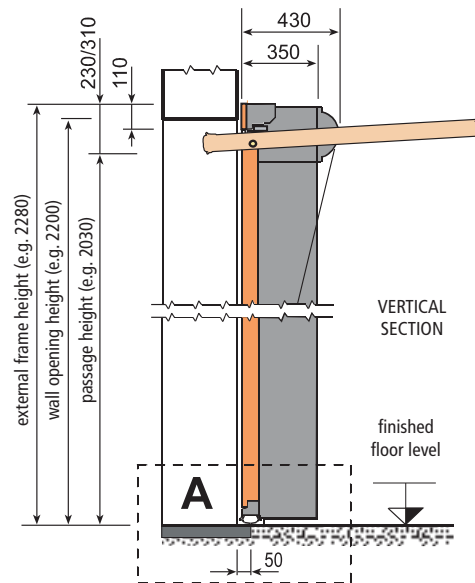

## Pedestrian door

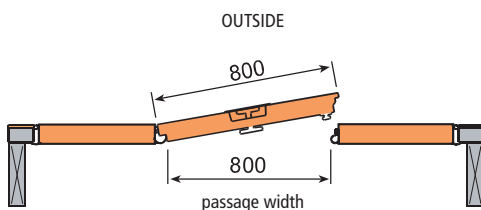

Height between floor and pedestrian door low part = 83 mm

## Detail of the door threshold

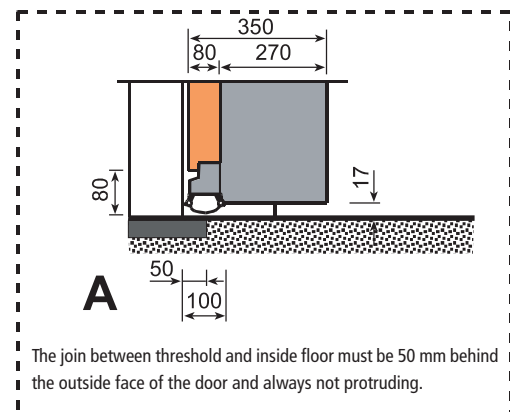



### Installation behind brickwork (recessed opening)

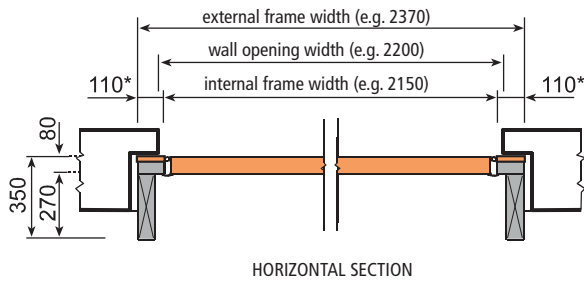

\*: becomes 135 mm in the cases shown in the size tables

PASSAGE WIDTH = internal frame width - 50 mm

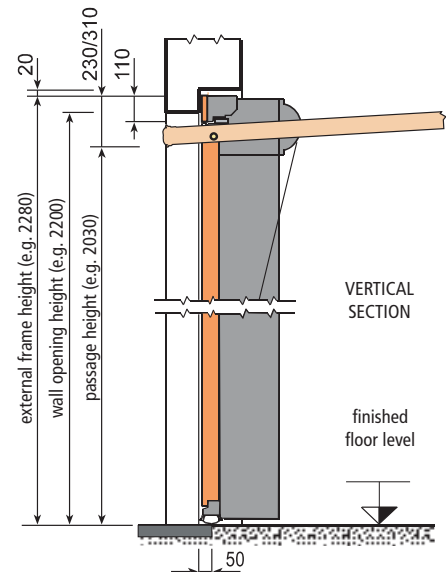

### Installation behind brickwork in arched wall opening

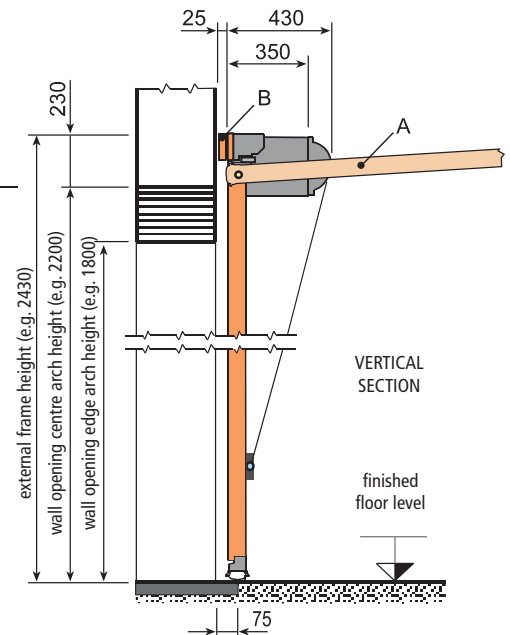
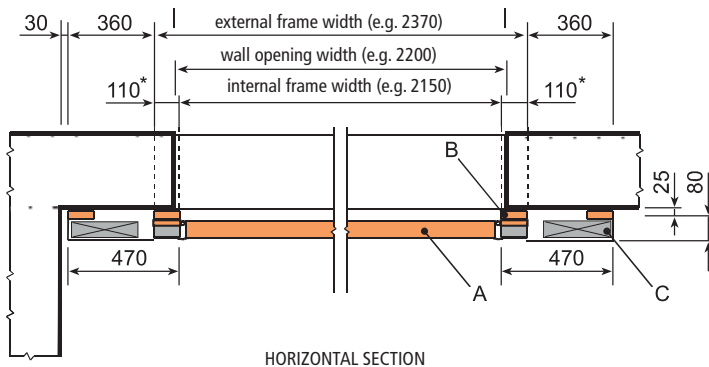
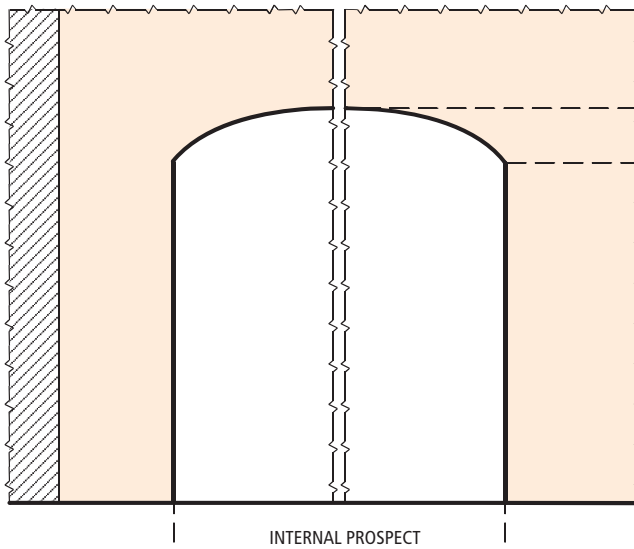

- A: door leaf with non protruding mechanism
- B: wooden safety boards (25 mm)
- C: counterweights turned through 90°

\*: becomes 135 mm in the cases shown in the size tables

PASSAGE WIDTH = internal frame width - 50 mm

# OVERALL SIZES - Garage door

Sizes in mm

## Protruding leaf (standard)

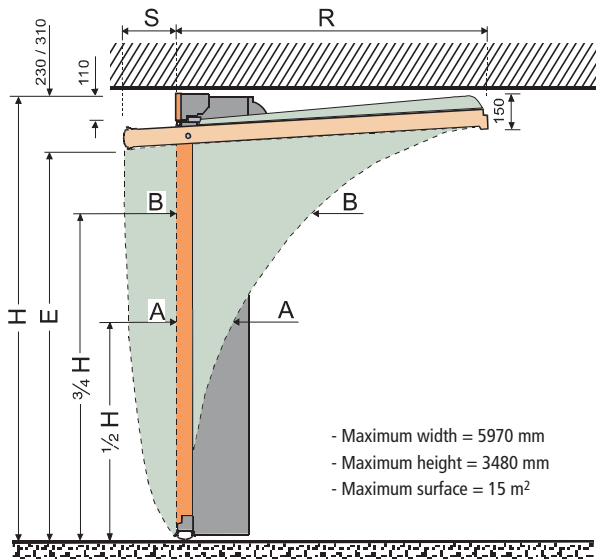

· Sizes in millimetres.

· During lifting the leaf trajectory does not exceed the external frame size of the door (H).

H	A-A	1/2H	B-B	3/4H	S	R	E
1980	400	990	900	1480	190	1700	1750
2030	400	1015	900	1520	190	1750	1800
2080	400	1040	900	1560	240	1750	1840
2130	400	1065	900	1600	240	1800	1890
2180	400	1090	900	1640	290	1800	1935
2230	400	1115	900	1670	290	1850	1985
2280	400	1140	900	1710	340	1850	2030
2330	400	1165	900	1750	340	1900	2080
2380	400	1190	900	1790	390	1900	2125
2430	400	1215	900	1820	390	1950	2175
2480	400	1240	900	1860	440	1950	2220
2530	400	1265	900	1900	440	2000	2270
2580	400	1290	900	1940	490	2000	2315
2630	400	1315	900	1970	490	2050	2365
2680	400	1340	900	2010	540	2050	2410
2730	400	1365	900	2050	540	2100	2460
2780	400	1390	950	2090	590	2100	2505
2830	400	1415	950	2120	590	2150	2555
2880	400	1440	950	2160	640	2150	2600
2930	400	1465	950	2200	640	2200	2650
2980	400	1490	950	2230	690	2200	2695
3030	400	1515	950	2270	690	2250	2745
3080	400	1540	950	2310	740	2250	2790
3130	400	1565	1000	2350	740	2300	2840
3180	400	1590	1000	2380	790	2300	2885
3230	400	1615	1000	2420	790	2350	2935
3280	400	1640	1000	2460	840	2350	2980
3330	400	1665	1000	2500	840	2400	3030
3380	400	1690	1000	2530	890	2400	3075
3430	400	1715	1000	2570	890	2450	3125
3480	400	1740	1000	2610	940	2450	3170

## Non protruding leaf (on request)

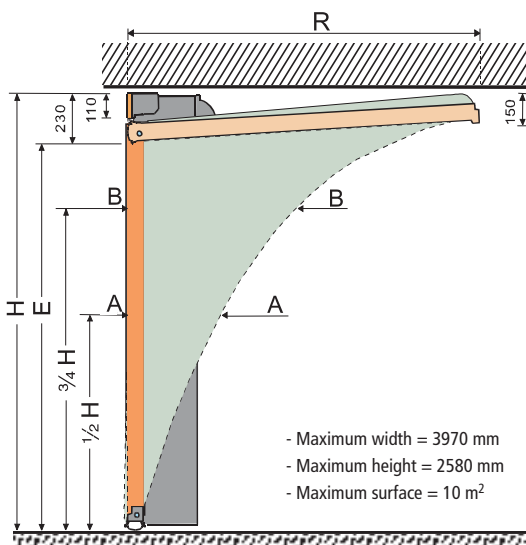

· Sizes in millimetres.

· During lifting the leaf trajectory does not exceed the external frame size of the door (H).

H	A-A	1/2H	B-B	3/4H	R	E
1980	520	990	980	1480	1900	1750
2030	530	1015	1005	1520	1950	1800
2080	540	1040	1030	1560	2000	1850
2130	550	1065	1055	1600	2050	1900
2180	560	1090	1080	1640	2100	1950
2230	570	1115	1105	1670	2150	2000
2280	580	1140	1130	1710	2200	2050
2330	590	1165	1155	1750	2250	2100
2380	600	1190	1180	1790	2300	2150
2430	610	1215	1205	1820	2350	2200
2480	620	1240	1230	1860	2400	2250
2530	630	1265	1255	1900	2450	2300
2580	640	1290	1280	1940	2500	2350

# SIZE TABLES - Garage door series Secur Plus

## Protruding leaf

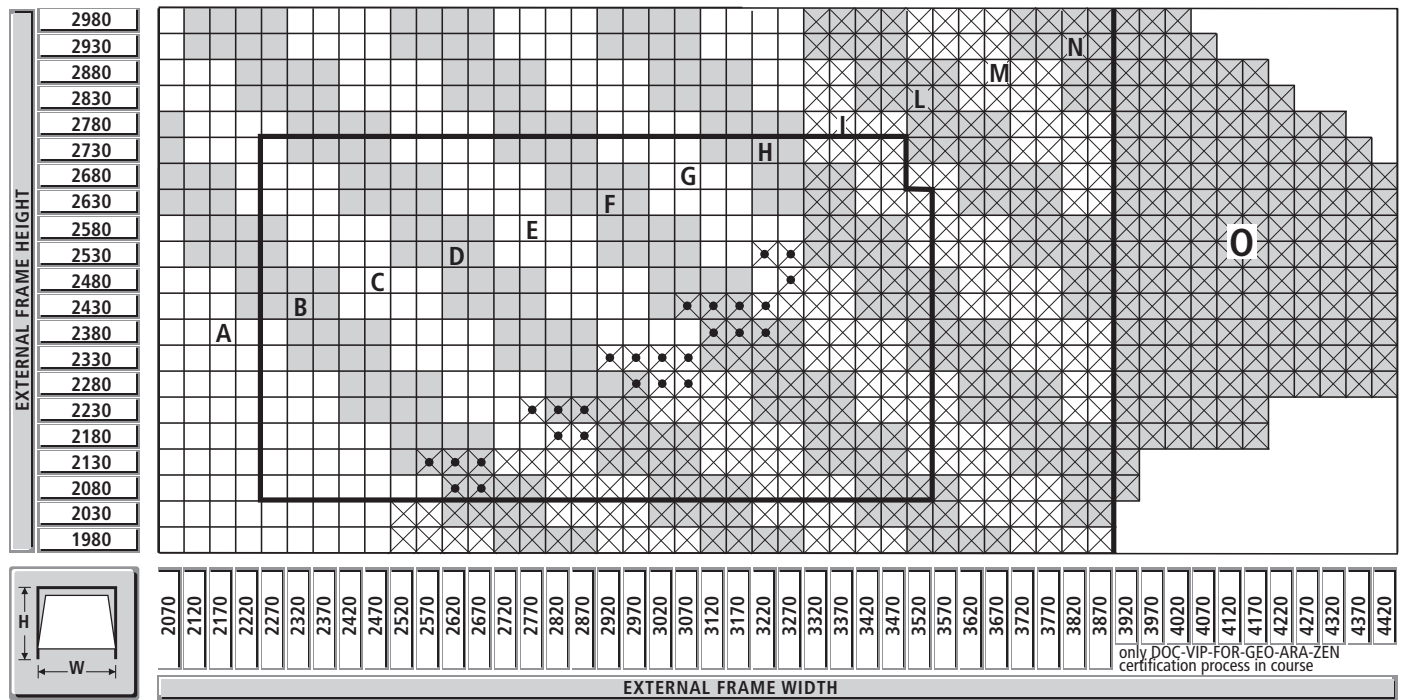

Production limit with central standard pedestrian door  
 NB: if with pedestrian door, the Securmatic motorisation is compulsory

Doors with frame uprights 135 mm wide (instead of 110 mm)

Doors with frame uprights 135 mm wide only in presence of pedestrian door

## Non protruding leaf

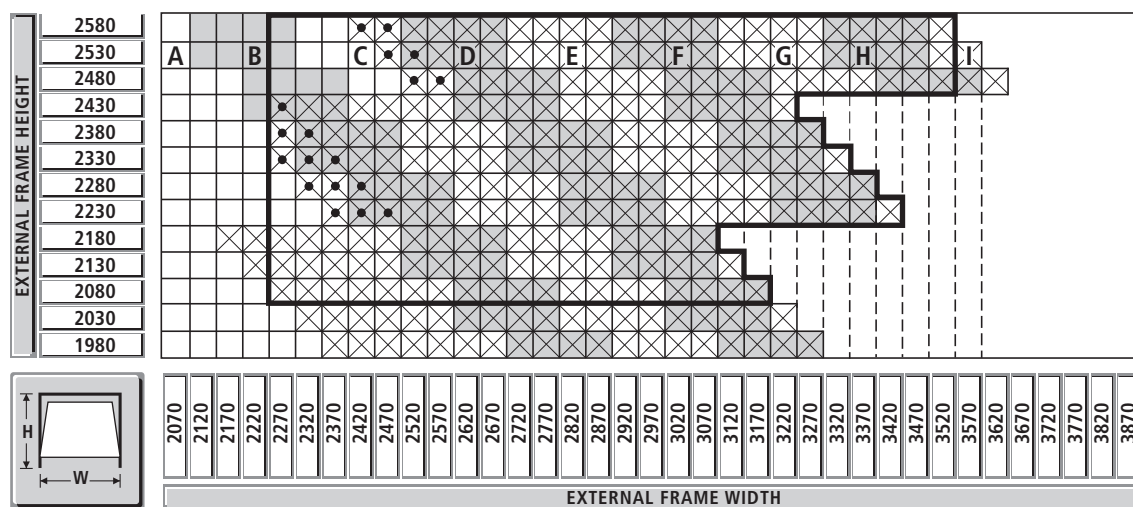

Production limit with central standard pedestrian door  
 NB: if with pedestrian door, the Securmatic motorisation is compulsory

Doors with frame uprights 135 mm wide (instead of 110 mm)

Doors with frame uprights 135 mm wide only in presence of pedestrian door

# SIZE TABLES - Garage door series Secur

## Protruding leaf

EXTERNAL FRAME HEIGHT	3430 / 3480																				EXTRA STANDARD DIMENSIONS (mod. DOC, VIP, GEO, TAU and ARA in Okoume wood not feasible)																			
	3330 / 3380																																							
	3230 / 3280																																							
	3130 / 3180																																							
	3030 / 3080																																							
	2930 / 2980																																							
	2830 / 2880																																							
	2730 / 2780	B	C	D	E	F	G	H	I	L	M	N	O	P	Q	R	S	T	U																					
	2630 / 2680																																							
	2530 / 2580																																							
	2430 / 2480																																							
	2330 / 2380																																							
	2230 / 2280																																							
	2130 / 2180	A																																						
	2030 / 2080																																							
1980																																								
	2070	2120 / 2170	2220 / 2270	2320 / 2370	2420 / 2470	2520 / 2570	2620 / 2670	2720 / 2770	2820 / 2870	2920 / 2970	3020 / 3070	3120 / 3170	3220 / 3270	3320 / 3370	3420 / 3470	3520 / 3570	3620 / 3670	3720 / 3770	3820 / 3870	3920 / 3970	4020 / 4070	4120 / 4170	4220 / 4270	4320 / 4370	4420 / 4470	4520 / 4570	4620 / 4670	4720 / 4770	4820 / 4870	4920 / 4970	5020 / 5070	5120 / 5170	5220 / 5270	5320 / 5370	5420 / 5470	5520 / 5570	5620 / 5670	5720 / 5770	5820 / 5870	5920 / 5970
EXTERNAL FRAME WIDTH																																								

\* SECUR doors higher than 2980 mm are not certified class 1.



Doors with frame uprights 135 mm wide (instead of 110 mm)

## Non protruding leaf

EXT. FRAME H.	2530 / 2580	B	C	D	E	F	G	H	I	L	M									
	2430 / 2480																			
	2330 / 2380																			
	2230 / 2280																			
	2130 / 2180	A																		
	2030 / 2080																			
1980																				
	2070	2120 / 2170	2220 / 2270	2320 / 2370	2420 / 2470	2520 / 2570	2620 / 2670	2720 / 2770	2820 / 2870	2920 / 2970	3020 / 3070	3120 / 3170	3220 / 3270	3320 / 3370	3420 / 3470	3520 / 3570	3620 / 3670	3720 / 3770	3820 / 3870	3920 / 3970
EXTERNAL FRAME WIDTH																				



Doors with frame uprights 135 mm wide (instead of 110 mm)

## SIZES - Entrance door

Sizes in mm

ATTENTION: the sizes are calculated on the components sizes (frame and counter frame) but, for the installation it is necessary to allow extra 5 mm per side.

Series PERFECTA		W			H
Ordering size		800	850	900	2200
Maximum dimension	MI	932	982	1032	2263
Counter frame passage	LC	806	856	906	2203
Net passage	LN	780	830	880	2190
Wall opening dimension	DF	922	972	1022	2258

Besides the above dimensions in chart, **widths from 750 to 1000 mm and heights from 1870 to 2500 mm**, in 10 mm increments, are feasible.

Series PERFECTA - Hidden hinge		W			H
Ordering size		800	850	900	2200
Maximum dimension	MI	996	1046	1096	2298
Counter frame passage	LC	806	856	906	2203
Net passage	LN	780	830	880	2190
Wall opening dimension	DF	996	1046	1096	2298

Besides the above dimensions in chart, **widths from 750 to 1000 mm and heights from 1870 to 2500 mm**, in 10 mm increments, are feasible.

Series OPTIMA		W			H
Ordering size		800	850	900	2100
Maximum dimension	MI	932	982	1032	2163
Counter frame passage	LC	806	856	906	2103
Net passage	LN	780	830	880	2090
Wall opening dimension	DF	922	972	1022	2158

Besides the above dimensions in chart, **widths from 750 to 1100 mm and heights from 1870 to 2500 mm**, in 10 mm increments, are feasible.

Series VALIDA		W			H
Ordering size		800	850	900	2100
Maximum dimension	MI	932	982	1032	2163
Counter frame passage	LC	806	856	906	2103
Net passage	LN	780	830	880	2090
Wall opening dimension	DF	922	972	1022	2158

Only the above standard dimensions are available

# SIZES - Entrance door

## Series Perfecta

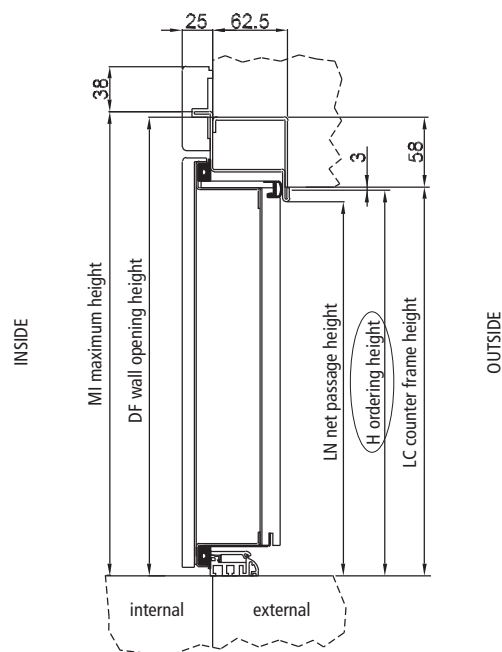
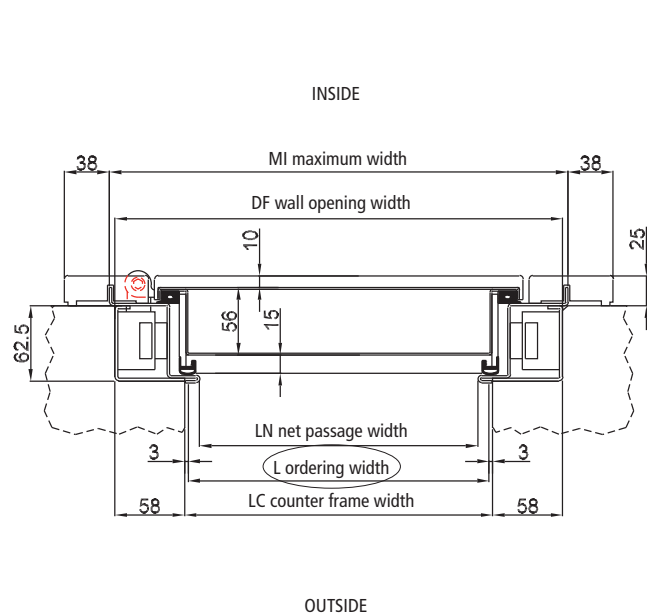

## Series Perfecta - Hidden hinge

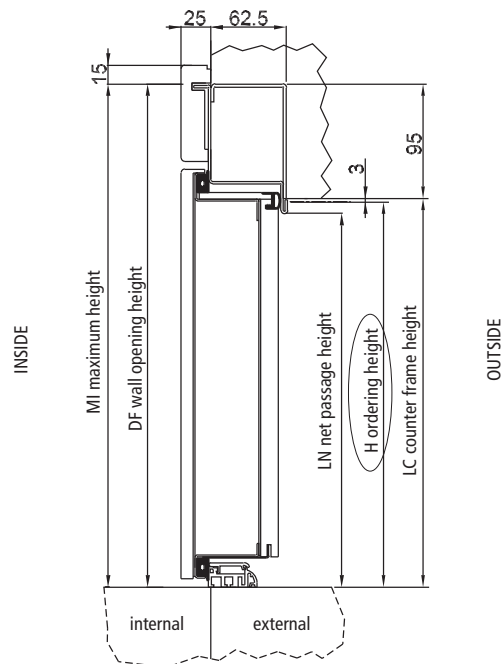
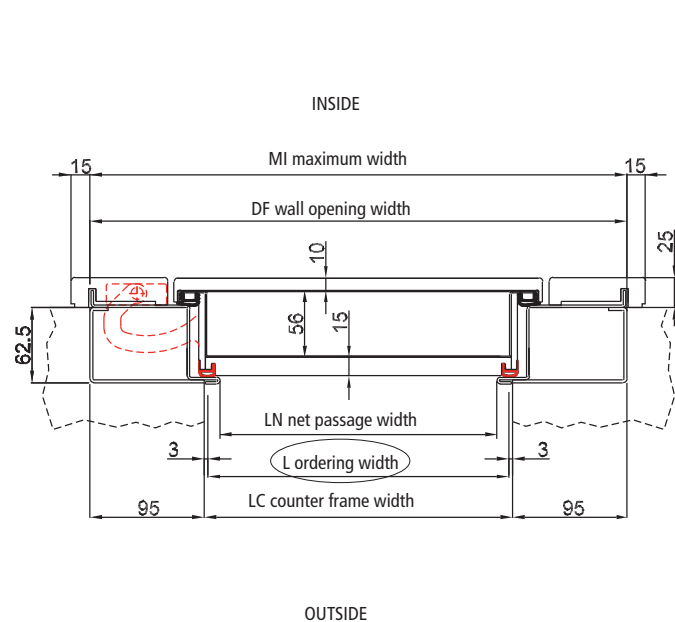

### Series Optima

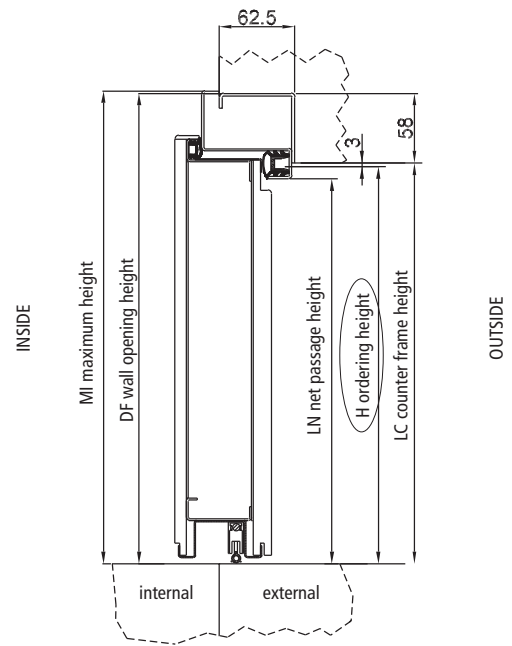
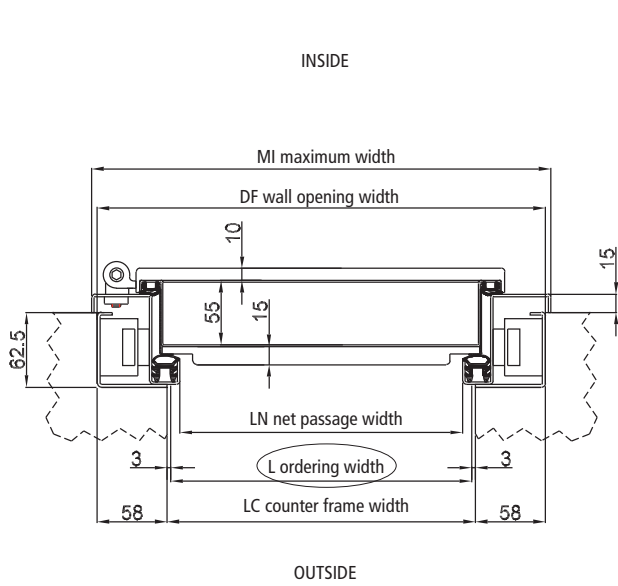

### Series Valida

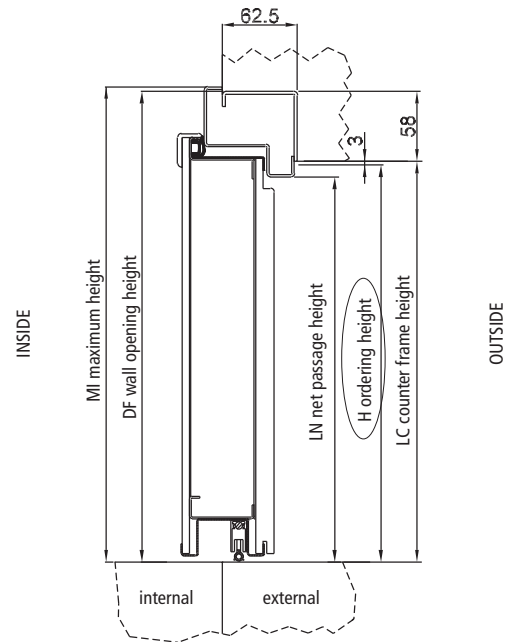
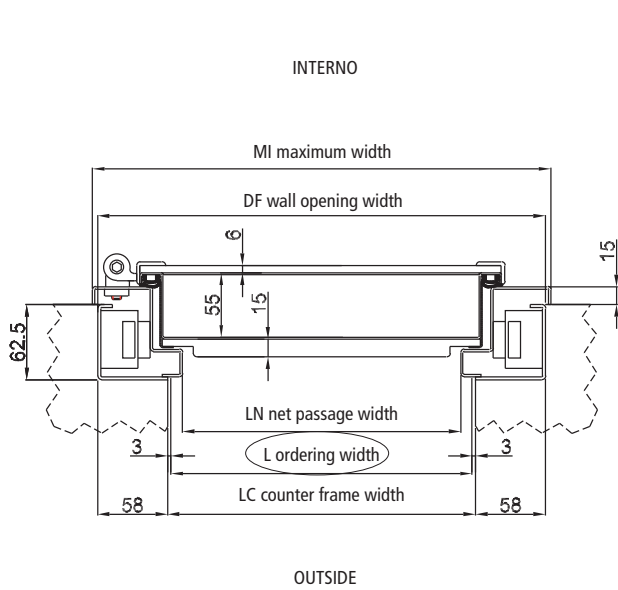

# SIZES MANUAL DOOR - Double leaf door

Sizes in mm

## Installation between brickwork (example with door opening towards inside)

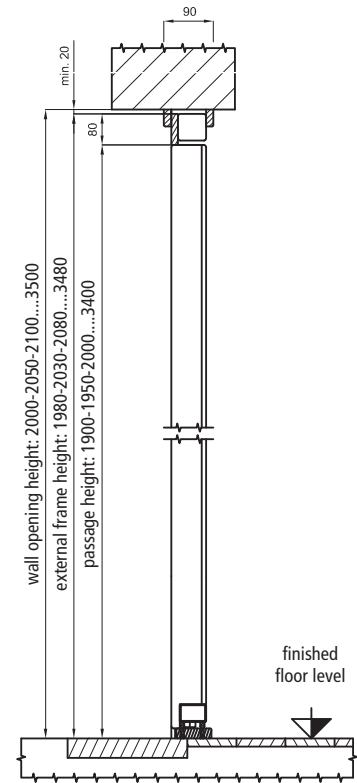
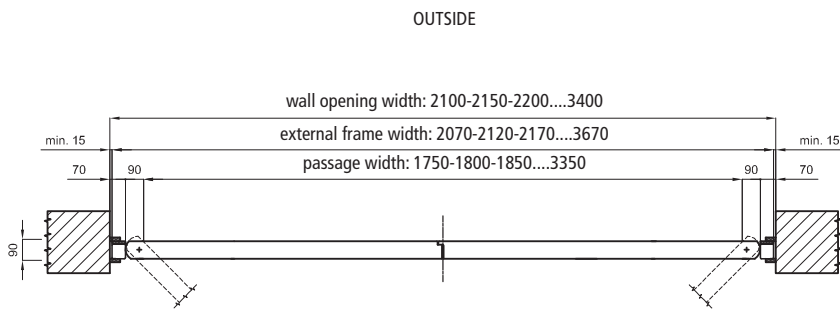

## Installation behind brickwork (example with door opening towards inside)

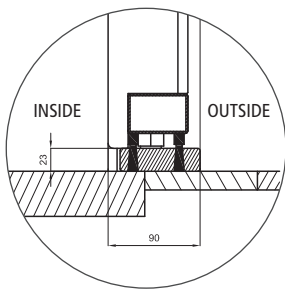
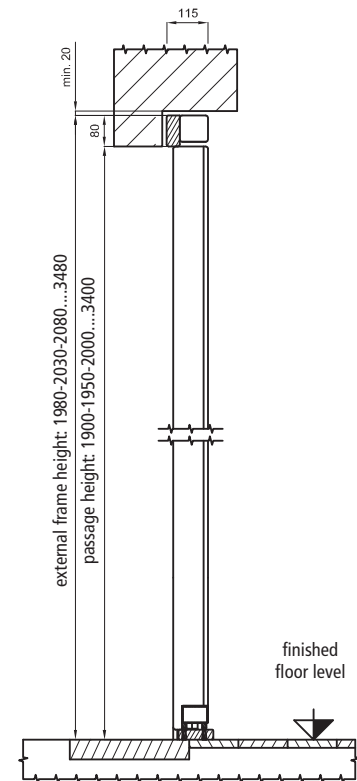
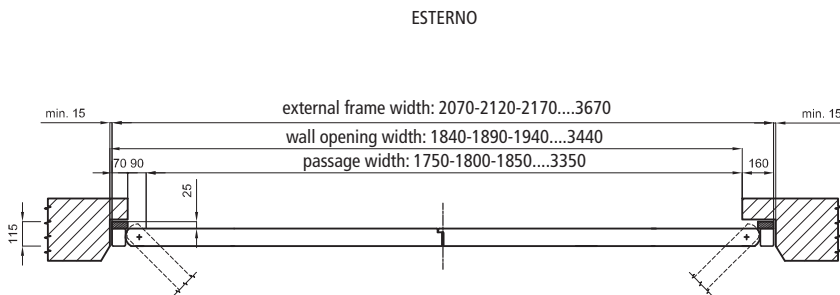

Detail threshold

## Table heights pedestrian door (mm)

DOOR H (mm)		2380	2430	2480	2530	2580	2630	2680	2730	2780	2830	2880	2930	2980	3030	3080	3130	3180	3230	3280	3330	3380	3430	3480
H opening pedestrian door	FOR, VIP, DOC	1889	1939	1989	2039	2089	2139	2189	2239	2089	2139	2189	2239	2089	2139	2166	2239	2089	2116	2189	2239	2089	2141	2189
	OLD 250 mm	/	/	/	/	1994	2044	2094	2144	2194	1994	2044	2094	2144	2194	1994	2044	2094	2144	2194	1994	2044	2094	2144
K = H opening pedestrian door + 72	FOR, VIP, DOC	/	/	/	/	2161	2211	2261	2311	2161	2211	2261	2311	2161	2211	2238	2311	2161	2188	2261	2311	2161	2213	2261
	OLD 250 mm	/	/	/	/	2066	2116	2166	2216	2266	2066	2116	2166	2216	2266	2066	2116	2166	2216	2266	2066	2116	2166	2216



# SIZES MOTORISED DOOR - Double leaf door

Sizes in mm

Table application motor type L or type S

DOOR NOMINAL WIDTH (mm)		2070	2120	2170	2220	2270	2320	2370	2420	2470	2520	2570	2620	2670	2720	2770	2820	2870	2920	2970	3020	3070	3120	3170	3220	3270	3320	3370	3420	3470	3520	3570	3620	3670	
WITH PEDESTRIAN DOOR	DOC, VIP	L	L	L	L	L	L	S	S	S	S	S	S	S	S	S	S	S	S	S	S	S	S	S	S	S	S	S	S	S	S	S	S	S	S
	FOR, OLD, SPI	L	L	L	L	L	L	S	S	S	S	S	S	S	S	S	S	S	S	S	S	S	S	S	S	S	S	S	S	S	S	S	S	S	S
	BIG, EGO	L	L	L	L	L	L	S	S	S	S	S	S	S	S	S	S	S	S	S	S	S	S	L	L	L	L	L	L	L	L	L	L	L	L
WITHOUT PEDESTRIAN DOOR	BIG, EGO, FOR, OLD, SPI	S	S	S	S	S	S	S	S	S	S	S	S	S	L	L	L	L	L	L	L	L	L	L	L	L	L	L	L	L	L	L	L	L	
	DOC, VIP	S	S	S	S	S	S	S	S	S	S	S	S	S	S	S	S	S	S	S	S	S	S	S	S	S	S	S	S	S	S	S	S	S	S

Table motor sizes type L or type S

TYPE L	A	B	C	D	E	K
	720	8	104	129	900	Table page 128

TYPE S	A	B	C	D	E	K
	920	78	159	184	1100	Table page 128

Installation between brickwork (horizontal section)

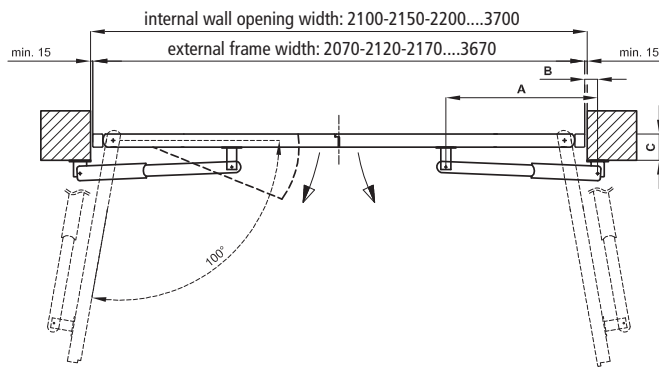

For all installation types (vertical section)

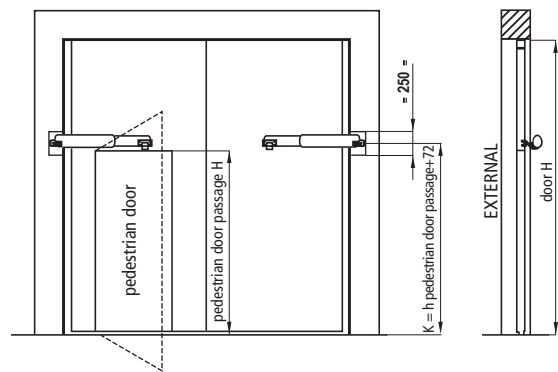

Installation behind brickwork with thickening boards (horizontal section)

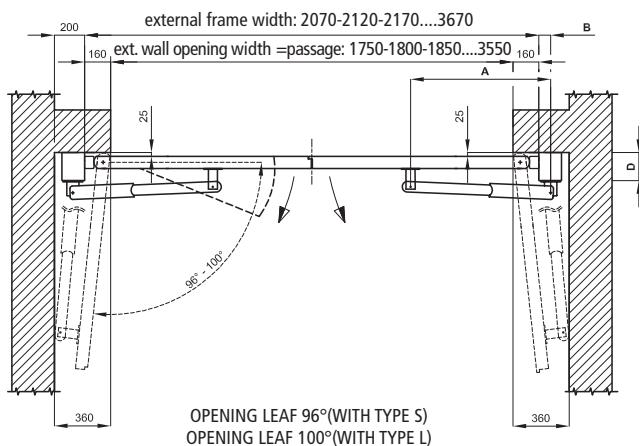

Installation between brickwork with recess for motorisation (horizontal section)

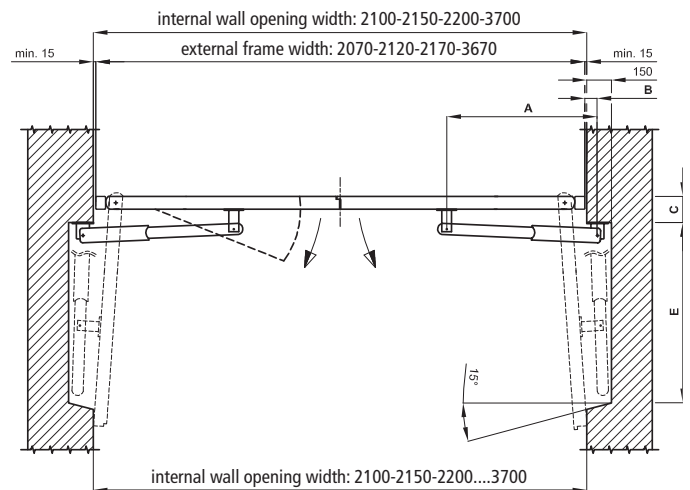

## SPECIFICATIONS FOR GARAGE DOORS series SECUR PLUS

- N. ... garage door/s produced by Silvelox certified burglar resistant CLASS 3 according to norm EN 1627 on safety topic.

- Wall opening: Width...x Height ... mm

Installation: between opening behind opening

External frame sizes: Width...x Height ... mm

- Garage door with lateral counterweights, without ceiling tracks. Minimum outward protrusion of leaf during and after opening. Manual opening with self-lifting effect.
- Leaf made of tubular steel frame and of 80 mm thick marine multilayer sandwich panels from 2 to 3 containing a highly resistant steel barrier. All of the door areas possibly subject to intrusion attempts are reinforced with manganese steel sheets and profiles.
- Thermal insulation obtained with synthetic expanded material.
- Upper crossbar and frame uprights reinforced with steel brackets.
- Rubber seal for finger protection between frame and leaf, rubber seal with double lateral protrusion for protection against impacts on the base of the leaf.
- Internal weather proof seal along 3 sides.
- External handle in aluminium varnished Platinbronze, Platinsilver, Antique Bronze, Brass or chosen RAL colour, completely embedded in the door leaf.
- Lock with anti-unthreading cylinder and manganese sheet protection.
- Pair of vertical and lateral moving bolts, actioned by drill-proof and anti-unthreading cylinders, with key from inside (from outside on request).
- Supply of 5 identical keys, patented and irreproducible.
- Metal components in steel sheet grey colour.
- Pre-arrangement for electro-mechanic motorisation positioned in the frame crossbar.

### ACCESSORIES:

- Pedestrian door at leaf centre, opening outwards, right pull, with motorised blockage actioned by the Securmatic motorisation.
- Opening closing mechanism for non protruding leaf.
- Counterweight turned through 90° and adjacent to the frame. RX int. v. LFT int. v.
- External wooden fascia boards 2500 or 3000 mm wide with insulating material.
- Inserts in stainless steel combined with handle and lower leaf crossbar varnished Platinsilver available only on VIP, FOR and GEO.

### MOTORISATION:

- SECURMATIC device: electro-mechanic actuator for leaf opening/closing and control of safety bolts with two flashing lights and safety photocells.
- Arrangement for connection to alarm system.
- Two channel receiver (inserted in the Securmatic control unit) or four channel receiver in box for outside use with self learning code, frequency 433.92 MHz.
- N. ...two channel remote control, frequency 433.92 MHz, rolling code, cloning proof (the second channel is always used to open the pedestrian door if present).
- N. ... four channel remote control, frequency 433.92 MHz, rolling code, cloning proof.

### DOOR MODELS FOR GARAGE DOOR series SECUR PLUS:

- Wood grooved on external side according to following drawings:
  - ARA: horizontal and vertical staves combined proportionately to leaf surface.
  - ARC: tiles with angles rectangular and curved, number and dimension proportionate to leaf surface.
  - BIG: tiles, number and dimensions proportionate to the leaf surface.
  - DOC: vertical staves 100 mm wide.
  - EGO: tiles, number proportionate to leaf surface.
  - FOR: horizontal staves 200 mm high.
  - GEO: vertical and horizontal staves with uniform height and proportionate to leaf height.
  - OLD: horizontal staves 225 mm high.
  - SPI: (45°) inclined "herringbone pattern" staves with upward vertex.
  - TAU: horizontal staves with uniform height, grooved by horizontal and vertical lines with different depth.
  - TOP: tiles of same dimension, number proportionate to leaf surface.
  - VIP: vertical staves 200 mm wide.
  - ZEN: horizontal staves with uniform height and proportionate to leaf height, grooved by a deeper marked square line.
  - CDA: as per drawing.

### FINISH GARAGE DOOR series SECUR PLUS:

- Protection with transparent varnish and acrylic water based satin finish in impregnating stain standard colours:
  - honey A 102.1 oak A 102.2 douglas A 102.3 cherry A 102.4 mahogany A 102.5 walnut A 102.6 green A 102.7 as per sample
- Protection with satin covering and acrylic water based satin finish, in colours similar RAL standard and on request:
  - 9010 (pure white) 7044 (silk grey) 6033 (mint turquoise) 6009 (pine green) 6005 (moss green) 3011 (brown red) other colours on request.

## SPECIFICATIONS FOR GARAGE DOOR series SECUR

- N. ... garage door/s produced by Silvelox certified burglar resistant CLASS 1 according to norm EN 1627 on safety topic.

- Wall opening: Width...x Height ... mm

Installation:  between opening  behind opening

External frame size: Width...x Height ... mm

- Garage door with lateral counterweights, without ceiling tracks. Minimum outward protrusion of leaf during and after opening. Manual opening with self-lifting effect.
- Leaf made of tubular steel frame and of 80 mm thick marine multilayer sandwich panels from 2 to 7.
- Rubber seal for finger protection between frame and leaf, rubber seal with double lateral protrusion for protection against impacts on the base of the leaf.
- Internal weather proof seal along 3 sides.
- External handle in aluminium varnished Platinbronze, Platinsilver, Antique Bronze, Brass or chosen RAL colour, completely embedded in the door leaf.
- Lock with anti-unthreading cylinder and three coded keys.
- Metal components in steel sheet grey colour.
- Pre-arrangement for electro-mechanic motorisation positioned in the frame crossbar.

### ACCESSORIES:

- Pedestrian door at leaf centre, opening outwards, right or left pull
- Opening closing mechanism for non protruding leaf.
- Counterweight turned through 90° and adjacent to the frame. RX int.v. LFT int.v.
- Pair of vertical bolts (additional security), positioned right and left of the leaf internal view.
- N. ... rectangular windows fixed or tilting in double polycarbonate sheet, 6 mm thick.
- N. ... rectangular windows fixed or tilting with external sheet in security glass, 4+4 mm thick.
- Glazed transom, 80 mm thick, enclosing two or more windows with double polycarbonate sheet 6 mm thick.
- Transom, 80 mm thick, grooved as the external leaf or flat.
- Rectangular ventilation grill with double weathered metal blades, grey colour.
- External wooden fascia boards 2500 or 3000 mm wide with insulating material.
- Inserts in stainless steel combined with handle and lower leaf crossbar varnished Platinsilver available only on VIP, FOR and GEO.

### MOTORISATION:

- COMBIMATIC device: electro-mechanic actuator for leaf opening/closing with two flashing lights and safety photocells.
- BLOCKMATIC device: electro-mechanic device for locking/unlocking of two supplementary vertical safety bolts.
- Arrangement for connection to alarm system.
- Two channel receiver (inserted in the Combimatic control unit) or four channel receiver in box for outside use with self learning code, frequency 433.92 MHz.
- N. ...two channel remote control, frequency 433.92 MHz, rolling code, cloning proof.
- N. ... four channel remote control, frequency 433.92 MHz, rolling code, cloning proof.

### DOOR MODELS FOR GARAGE DOOR series SECUR:

- Wood grooved on external side according to following drawings:
- ARA: horizontal and vertical staves combined proportionately to leaf surface.
- ARC: tiles with angles rectangular and curved, number and dimension proportionate to leaf surface.
- BIG: tiles, number and dimensions proportionate to the leaf surface.
- DOC: vertical staves 100 mm wide.
- EGO: tiles, number proportionate to leaf surface.
- FOR: horizontal staves 200 mm high.
- GEO: vertical and horizontal staves with uniform height and proportionate to leaf height.
- OLD: horizontal staves 225 mm high.
- SPI: (45°) inclined "herringbone pattern" staves with upward vertex.
- TAU: horizontal staves with uniform height, grooved by horizontal and vertical lines with different depth.
- TOP: tiles of same dimension, number proportionate to leaf surface.
- VIP: vertical staves 200 mm wide.
- ZEN: horizontal staves with uniform height and proportionate to leaf height, grooved by a deeper marked square line.
- CDA: as per drawing.

### FINISH GARAGE DOOR series SECUR:

- Protection with transparent varnish and acrylic water based satin finish in impregnating stain standard colours:
- honey A 102.1  oak A 102.2  douglas A 102.3  cherry A 102.4  mahogany A 102.5  walnut A 102.6  green A 102.7  as per sample
- Protection with satin covering and acrylic water based satin finish, in colours similar RAL standard and on request:
- 9010 (pure white)  7044 (silk grey)  6033 (mint turquoise)  6009 (pine green)  6005 (moss green)  3011 (brown red)  other colours on request.

## SPECIFICATIONS FOR ENTRANCE DOOR series PERFECTA

• N. ... entrance door/s produced by Silvelox certified (1 leaf) burglar resistant CLASS 4, water resistance CLASS 2, resistance to wind CLASS 5, thermal transmittance 3,56, air permeability CLASS 2, noise reduction 40 dB.

• Wall opening: Width...x Height ... mm

Installation:  between opening  behind opening  between and behind opening

External frame size: Width...x Height ... mm

STRUCTURE:

• Sizes single leaf from width 750 to 1000 mm x height from 1870 to 2500 mm - from width 1010 to 1100 mm requires feasibility (certifications excluded) – double leaf from width 950 to 1600 mm x height from 1870 to 2500 mm.

• Inside of leaf in double electro galvanised steel thick 15/10 (external), insulated with polystyrene and with 5 vertical omega reinforcements 10/10.

• Frame in steel sheet 20/10 thick, pressbent and powder varnished grey colour.

• Double cylinder Astral Sigillo multifunctional lock with homeowner function and internal thumb turn.

• Hidden hinge with adjustable opening of the leaf from 90° to 135°.

STANDARD CHARACTERISTICS:

• Insulation with sound absorbent material.

• Aluminium single contact threshold.

• Handle Platinbronze, Platinsilver, or in brass PVD treated.

• Leaf recess covered in wood.

• Internal frame cover boards in wood.

• Double seal between leaf and frame.

• Opening side: push right or left.

SECURITY CLOSURES:

• N° 1 upper double lateral deviator

• N° 1 lower double lateral deviator

• N° 6 fixed bolts

PANELS:

• Internal smooth panel - 10 mm Okoume multilayer.

• External panel - 15 mm in different woods and models.

ENTRANCE DOORS MODELS:

• Pantographed models in Okoume or Northern Spruce:

VIP  TAU

FOR  ZEN

GEO  SPI

ARA

• Pantographed models in Okoume or Northern Spruce:

BIG  ARC

EGO  OLD

TOP

• Models with solid inserts in Oak or Douglas:

VIP  TAU

FOR  ZEN

GEO  SPI

ARA

• Models with solid inserts in Okoume or Northern Spruce or Oak or Douglas:

BIG  ARC

EGO  OLD

TOP

FINISH ENTRANCE DOOR:

Protection with transparent varnish and acrylic water based satin finish in impregnating stain standard colours:

honey A 102.1  oak A 102.2  douglas A 102.3  cherry A 102.4  mahogany A 102.5  walnut A 102.6  green A 102.7  as per sample

Protection with satin covering and acrylic water based satin finish, in colours similar RAL standard and on request:

9010 (pure white)  7044 (silk grey)  6033 (mint turquoise)  6009 (pine green)  6005 (moss green)  3011 (brown red)  other colours on request.

## SPECIFICATIONS FOR ENTRANCE DOOR series OPTIMA

- N. ... entrance door/s produced by Silvelox certified (1 leaf) burglar resistant CLASS 3, resistance to wind CLASS 3, air permeability CLASS 2, noise reduction 40 dB and certified (2 leaves) burglar resistant CLASS 3, resistance to wind CLASS 3, air permeability CLASS 2, noise reduction 29 dB.

- Wall opening: Width...x Height ... mm

Installation:  between opening  behind opening  between and behind opening

External frame size: Width...x Height ... mm

### STRUCTURE:

- Sizes single leaf from width 750 to 1100 mm x height from 1870 to 2500 mm - double leaf from width 950 to 1600 mm x height from 1870 to 2500 mm.
- Inside of leaf in double sheet electro galvanised thick 12/10, insulated with polystyrene and with 2 vertical omega reinforcements.
- Frame in steel sheet 20/10 thick, pressbent and powder varnished RAL 8019 brown.
- One cylinder Revolution lock with internal thumb turn.

### STANDARD CHARACTERISTICS:

- Insulation with sound absorbent material.
- Draft excluder built into door leaf base.
- Handle Platinbronze, Platinsilver, or in brass PVD treated.
- Leaf recess covered in stainless steel sheet.
- Seal on leaf and frame.
- Opening side: push right or left.

### SECURITY CLOSURES:

- N° 1 upper double lateral deviator
- N° 1 lower double lateral deviator
- N° 2 intermediate single lateral deviators
- N° 6 fixed bolts

### PANELS:

- Internal smooth panel - 10 mm Okoume multilayer.
- External panel - 15 mm in different woods and models.

### ENTRANCE DOOR MODELS:

- Pantographed models in Okoume or Northern Spruce:

- |                              |                              |
|------------------------------|------------------------------|
| <input type="checkbox"/> VIP | <input type="checkbox"/> TAU |
| <input type="checkbox"/> FOR | <input type="checkbox"/> ZEN |
| <input type="checkbox"/> GEO | <input type="checkbox"/> SPI |
| <input type="checkbox"/> ARA |                              |

- Pantographed models in Okoume or Northern Spruce:

- |                              |                              |
|------------------------------|------------------------------|
| <input type="checkbox"/> BIG | <input type="checkbox"/> ARC |
| <input type="checkbox"/> EGO | <input type="checkbox"/> OLD |
| <input type="checkbox"/> TOP |                              |

- Models with solid inserts in Oak or Douglas:

- |                              |                              |
|------------------------------|------------------------------|
| <input type="checkbox"/> VIP | <input type="checkbox"/> TAU |
| <input type="checkbox"/> FOR | <input type="checkbox"/> ZEN |
| <input type="checkbox"/> GEO | <input type="checkbox"/> SPI |
| <input type="checkbox"/> ARA |                              |

- Models with solid inserts in Okoume or Northern Spruce or Oak or Douglas:

- |                              |                              |
|------------------------------|------------------------------|
| <input type="checkbox"/> BIG | <input type="checkbox"/> ARC |
| <input type="checkbox"/> EGO | <input type="checkbox"/> OLD |
| <input type="checkbox"/> TOP |                              |

### ENTRANCE DOOR FINISH:

- Protection with transparent varnish and acrylic water based satin finish in impregnating stain standard colours:

- honey A 102.1  oak A 102.2  douglas A 102.3  cherry A 102.4  mahogany A 102.5  walnut A 102.6  green A 102.7  as per sample

- Protection with satin covering and acrylic water based satin finish, in colours similar RAL standard and on request:

- 9010 (pure white)  7044 (silk grey)  6033 (mint turquoise)  6009 (pine green)  6005 (moss green)  3011 (brown red)  other colours on request.

## SPECIFICATIONS FOR ENTRANCE DOOR series VALIDA

- N. ... entrance door/s produced by Silvelox certified burglar resistant CLASS 2, resistance to wind CLASS 3, air permeability CLASS 2, noise reduction 32 dB.

- Wall opening: Width...x Height ... mm

Installation:  between opening  behind opening  between and behind opening

External frame size: Width...x Height ... mm

### STRUCTURE:

- Sizes single leaf width 800 – 850 – 900 mm x height 2100 mm.
- Inside of leaf in sheet electro galvanised thick 10/10, insulated with polystyrene and with a vertical omega reinforcement.
- Frame in steel sheet 20/10 thick, pressbent and powder varnished RAL 8019 brown.
- Sage Easy Change lock.

### STANDARD CHARACTERISTICS:

- Insulation with sound absorbent material.
- Draft excluder built into door leaf base.
- Handle in aluminium anodised bronze colour.
- Leaf recess covered in prevarnished brown colour sheet.
- Seal on leaf.
- Opening side: push right or left.

### SECURITY CLOSURES:

- N° 1 upper lateral deviator.
- N° 1 lower lateral deviator.
- N° 4 fixed bolts.

### PANELS:

- Internal smooth panel – 6 mm engineered Tanganica or Mahogany.
- External panel – 15 mm in Okoume multilayer in different models.

### ENTRANCE DOOR MODELS:

- Pantographed models in Okoume or Northern Spruce:

- |                              |                              |
|------------------------------|------------------------------|
| <input type="checkbox"/> VIP | <input type="checkbox"/> TAU |
| <input type="checkbox"/> FOR | <input type="checkbox"/> ZEN |
| <input type="checkbox"/> GEO | <input type="checkbox"/> SPI |
| <input type="checkbox"/> ARA | <input type="checkbox"/> BIG |
| <input type="checkbox"/> ARC | <input type="checkbox"/> EGO |
| <input type="checkbox"/> OLD | <input type="checkbox"/> TOP |

### ENTRANCE DOOR FINISH:

- On Okoume:

Protection with transparent varnish and acrylic water based satin finish in impregnating stain standard colours:

honey A 102.1  oak A 102.2  douglas A 102.3  cherry A 102.4  mahogany A 102.5  walnut A 102.6  green A 102.7  as per sample

Protection with satin covering and acrylic water based satin finish, in colours similar RAL standard and on request:

9010 (pure white)  7044 (silk grey)  6033 (mint turquoise)  6009 (pine green)  6005 (moss green)  3011 (brown red)  other colours on request.

- On Tanganica in the colours:

natural  clear  medium  cherry  medium dark  dark

- On Mahogany in the colours:

clear  medium  dark

- On Oak in the colours:

natural  honey

## SPECIFICATIONS FOR DOUBLE LEAF DOOR

- N. ... double leaf door/s produced by Silvelox CE labelled in manual version, pre-arranged or motorised with Came Ati motors.

- Wall opening: Width...x Height ... mm

Installation:  between opening  behind opening

External frame size: Width...x Height ... mm

- Manual opening double leaf door.
- External perimeter frame in steel tubular with multiple fixing points with expansion bolts or angular stirrups.
- Each leaf is made of a steel tubular frame and by one or more sandwich panels in multilayer marine wood 80 mm thick.
- Leaf base with brush against floor.
- Rubber seal for finger protection between frame and leaf.
- External knobs and internal handle in brass bronzed or Platinsilver.
- Security lock with three bolts and a spring lock with anti unthreading cylinder and three coded keys, standard supply.
- Extra bolts (1 top + 1 bottom) operated by the same lock.
- Secondary leaf closed with two bolts (bottom + top) controlled by a lever at man's height.
- Metal components in steel sheet grey colour.

### ACCESSORIES:

- Pedestrian door lowered in the main leaf, open towards inside, right push with same closing system of the main leaf (available from door nominal height 2580 mm).
- Electric lock for door or pedestrian door.
- Hydraulic closing device.
- N. ... rectangular windows fixed or tilting in double polycarbonate sheet, 6 mm thick.
- N. ... rectangular windows fixed or tilting with external sheet in security glass, 4+4 mm thick.
- Glazed transom, 80 mm thick, enclosing two or more windows with double polycarbonate sheet 6 mm thick.
- Transom, 80 mm thick, grooved as the external leaf or flat.
- Rectangular ventilation grill with double weathered metal blades, grey colour.
- Personalised handles.
- Internal and/or external perimeter wooden fascia boards.
- Mail box in the leaf with external flap in shiny or bronzed brass, inside box with tilting opening.
- Lower big fascia in wood protruding with or without cover in brass.

### MOTORISATION:

- Arrangement for electro-mechanic motorisation Came series ATI with arms for opening towards inside.
- Motorisation Came series ATI made by 2 electro-mechanic piston actuators, electric board, electric lock, internal and external photocells.
- Two channel or four channel receiver in box for outside use with self learning code, frequency 433.92 MHz.
- N. ... two channel remote control, frequency 433.92 MHz, rolling code, cloning proof.
- N. ... four channel remote control, frequency 433.92 MHz, rolling code, cloning proof.

### DOUBLE LEAF DOORS MODELS:

- Wood work on the external side according to the following drawings:
  - vertical or horizontal staves 100 or 200 mm wide or high.
  - staves in herringbone pattern (45°) with upward vertex.
  - horizontal staves with groove and tongue joints, 250 mm high.
  - tiles with angles straight or curved; number and dimensions in relation to the leaf surface.
  - CDA: as per drawing.

### DOUBLE LEAF DOOR FINISH:

- Protection with transparent varnish and acrylic water based satin finish in impregnating stain standard colours:
  - honey A 102.1  oak A 102.2  douglas A 102.3  cherry A 102.4  mahogany A 102.5  walnut A 102.6  green A 102.7  as per sample
- Protection with satin covering and acrylic water based satin finish, in colours similar RAL standard and on request:
  - 9010 (pure white)  7044 (silk grey)  6033 (mint turquoise)  6009 (pine green)  6005 (moss green)  3011 (brown red)  other colours on request.